

1 = 1.44MB Diskette X (2²⁶) = 80TB of **Compressed Video**
2 = 80TB of **Compressed Video on 2 LTO-10 40TB Tapes**
Send 1.44MB Diskette Starlink at 22Mbps at 0.654 Seconds
Or 80TB LTO-10 Starlink at 22Mbps at 1.152 Years
Same Data 1.44MB Diskette or 80TB LTO-10 Tapes
Your Choice 0.654 Seconds or 1.152 Years = **Same Data**

80TB Conversion Rate at 25GbE FtlSpinUp = 8.9 Hours
80TB Conversion Rate at 400MBs LTO-10 = 55.56 Hours

80TB **Compressed Video Modern Compression 4X = 20TB**
20TB Modern Compression Starlink at 22Mbps = 105.2 Days

1.44MB Diskette FtlSpinUp Starlink at 22Mbps = 0.654 Sec.
Up = 80TB Conversion Rate 25GbE FtlSpinUp = 8.9 Hours
Down=80TB Conversion Rate 25GbE FtlSpinUp = 8.9 Hours
105.2 Days / 17.8 Hours = 141.8 X **FASTER**



USA TERRITORIES ONLY



USA TERRITORIES ONLY

FtlSpinUp (1)

FtlSpinUp (2)



1.44MB / 4.4MBs UpLink
44Mbps = 0.327 Seconds
22Mbps = 0.654 Seconds



80TB / 4.4MBs UpLink
44Mbps = 210.437 Days
22Mbps = 1.152 Years



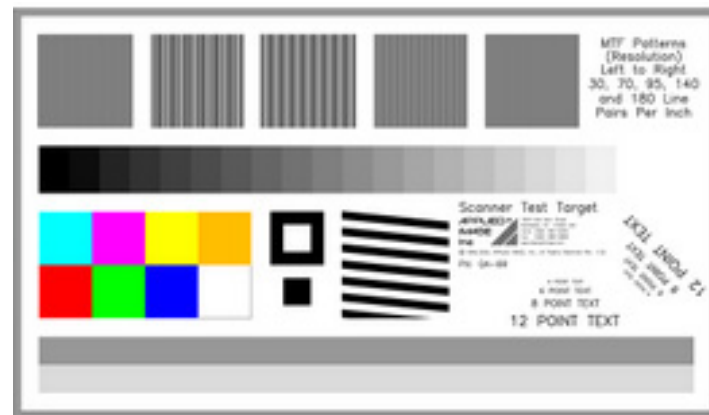
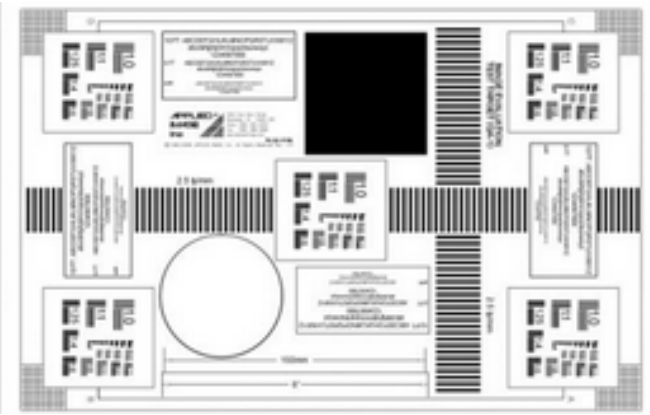

USA TERRITORIES ONLY

www.FtlSpinUp.com

Secured Desktop Data 120

**FtlSpinUp is 100% Lossless
No Video Compression Necessary**

**FtlSpinUp will work with any Video
Compression of Any Kind
Previously Stored Compressed
or not**

**Lossless Raw Pixel Data without
Any Lossy Video Compression of
Any Kind being Necessary, and
Lossless is always better for any
Machine Analysis**

Amazon = 10,000,000,000,000,000
\$2,000,000 Dollars + Every Year Peta Tera Giga Mega Kilo Hecto

Azure = 10,000,000,000,000,000
\$2,000,000 Dollars + Every Year Peta Tera Giga Mega Kilo Hecto

Google = 10,000,000,000,000,000
\$2,000,000 Dollars + Every Year Peta Tera Giga Mega Kilo Hecto

Backblaze = 10,000,000,000,000,000
\$720,000 Dollars Every Year Peta Tera Giga Mega Kilo Hecto

Wasabi = 10,000,000,000,000,000
\$859,200 Dollars Every Year Peta Tera Giga Mega Kilo Hecto

Seagate Lyve Cloud = 10,000,000,000,000,000
\$7.50 TB/Mo Standard Peta Tera Giga Mega Kilo Hecto
\$900,000 Dollars Every Year

FtlSpinUp Internal Disk 1,342,177,280,000,000,000,000
10GbE FDX-25GbE HDX Zetta Exa Peta Tera Giga Mega Kilo Hecto

Optional Internal RAM DISK 6,710,886,400,000,000,000
Optional Data Base Package Exa Peta Tera Giga Mega Kilo Hecto

\$10,000 Dollars 1Time Hardware Included
\$120 Dollars Every Year Factory Triple Backup

Optional Starlink Near Real-Time 10GbE FDX or 25GbE HDX
18PB Stored File at 44Mbps Uplink = ~62 Seconds = 2.9 PbE

(2^26) Near Real-Time Base / (2^52) Experimental
Infinite Secured Desktop Data (Throughput Limited)
All Data Never Erased and Guaranteed for LIFE

FtlSpinUp Desktop sized Computer



**Intel E830 NIC two 10GbE or 25GbE
10GbE Full Duplex Near Real-Time
25GbE Half Duplex Near Real-Time
One 30TB Disk with Customer Storage**

FtlSpinUp Internal Disk 1,342,177,280,000,000,000
10GbE FDX-25GbE HDX Zetta Exa Peta Tera Giga Mega Kilo Hecto

\$10,000 Dollars **1Time** **Hardware Included**
\$120 Dollars **Every Year** **Factory Triple Backup**

**Zip files are entered into FtlSpinUp up to
90TB blocks that require 1.44 MB each on the
30TB Disk Drive. The 1.44 MB files are sent back
to the factory for triple redundancy 100% Guar-
anteed return, and never erased. A simple email
is used, and a return email for green light receipt.**

**Automatic sha512sum checksum bits are used
throughout the entire 1.44 MB file to ensure data
communication integrity.**

**The 1.44MB file will fit onto a diskette, however it
does not have any limitations as to storage media.**

FtlSpinUp

Intel Core Ultra 7 270K Plus

24 Cores

2 Fiber Optic - 10GbE / 25GbE

**Factory Triple Redundant Automated Backup
100% Guaranteed Data Sent to Factory**

90TB sent to any NAS at 10GbE is 25 Hours
90TB returned to any NAS at 10GbE is 25 Hours
Actual time may be greater depending on Disk Drive Array

90TB sent to any NAS at 25GbE is 10 Hours
90TB returned to any NAS at 25GbE is 10 Hours
Actual time may be greater depending on Disk Drive Array

**90TB sent with Starlink 22Mbs Uplink (No FtlSpinUp)
is 1.425 Years**
**90TB returned with Starlink 22Mbs Uplink (No FtlSpinUp)
is 1.425 Years**

FtlSpinUp Demo 60GB File at 25GbE is 24 Seconds

FtlSpinUp is Full Duplex 10GbE
3,728,270 Times More Storage than 360TB NAS
90TB sent to FtlSpinUp at 10GbE is 25 Hours
Only 1.44MB is used to store the 90TB
1.44MB returned from FtlSpinUp at 10GbE is 25 Hours
1.44MB is separated into 64 individual segments

FtlSpinUp is Half Duplex 25GbE
3,728,270 Times More Storage than 360TB NAS
90TB sent to FtlSpinUp at 25GbE is 10 Hours
Only 1.44MB is used to store the 90TB
1.44MB returned from FtlSpinUp at 25GbE is 10 Hours
1.44MB is separated into 64 individual segments

CargoBit (1Million Dollars+) is HDX 4 Tera bit Ethernet
90TB sent to Cargobit at 4TbE is 3.75 Minutes
Only 1.44MB is used to store the 90TB
1.44MB returned from FtlSpinUp at 4TbE is 3.75 Minutes
1.44MB is separated into 64 individual segments

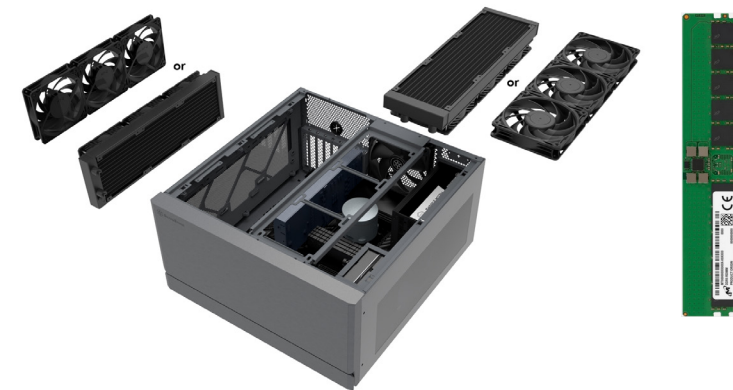
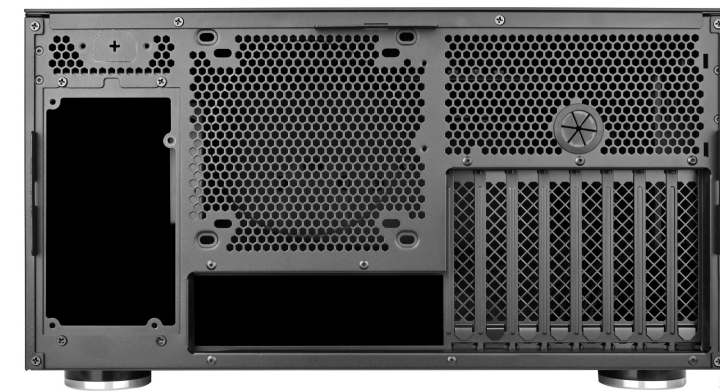

FtlSpinUp Intel Core Ultra 7 270K Plus 2 - 10GbE / 25GbE



FtlSpinUp

Data compression and deduplication on *reducible data* are now available with a guaranteed 5:1 result, or more on typical systems. The fine print of *reducible data* does not include many pre-compressed or non-compressible data formats, or *non-reducible data* formats such as compressed audio, compressed image and compressed video file formats, PDF, most office work file formats, all compression formats, pre-compressed Data Sets, and almost any professional commercial file format being used. Large voluminous amounts of Data storage can achieve 65:1 or more with pattern sensitive data, and deduplication. Actual performance may vary.

FtlSpinUp is a dedicated computer intensive lossless subspace conversion system for digital data storage and communication that goes far beyond normal pattern sensitive digital data compression. FtlSpinUp will work with most digital storage, and communication systems available without modification in any way, shape, or form.

FtlSpinUp is a lossless subspace conversion unit that in no way, shape, or form ever does any Data content or pattern analysis. FtlSpinUp is not pattern or content sensitive, and there is no such thing as non-compressible data, or *non-reducible data*. FtlSpinUp has always been very unique since 1983 with an all data 6:1 ratio.

FtlSpinUp lossless subspace conversion is up to (2^{26}) :1 at this time, not including any file formatting or pre compression ratio. FtlSpinUp subspace conversion requires simultaneous software threads of intense complex instruction set computer (CISC) time. All CISC cores will be 100% saturated per server. AI and GPU's are RISC.

Some custom hardware is included at each location for the physical security of FtlSpinUp. Once installed, FtlSpinUp can not be moved in any direction more than a couple of miles without termination of program. Special mobile FtlSpinUp locations are possible, if justified.

FtlSpinUp is a subspace conversion (state machine) only, and does not involve any normal processing of Data Center activity. Data is sent to FtlSpinUp in a maximum ultra compressed 7zip formatted file with a hash number from the customer, and returned to the customer in a much smaller (2^{26}) :1 maximum compressed FtlSpinUp formatted file with a unique hash number. The processed data, serial number, time, conversion hash are all registered and stored into the Deep Freezer of the state machine to guarantee future returning file integrity.

Similar to a read head placed after the write head on a tape machine that reads back what has just been written on the tape, FtlSpinUp reads back the subspace converted file and verifies the hash signature that every subspace conversion process starts with, that is provided by the customer when the original 7zip file is created. Read after Write subspace conversion system with hash, and a full bit level integrity comparison cycle will guarantee, and verify no bit loss for any future return to the original bit pattern before being sent out of the FtlSpinUp machine with up to a (2^{26}) subspace conversion.

The (2^{26}) :1 maximum compressed FtlSpinUp formatted file can then be manipulated with any conventional program, however the internal compressed subspace converted data is not available for use by any conventional program without being returned, or having a CargpBit subspace conversion first.

Every FtlSpinUp state machine is unique, and generate very different file contents that are not compatible with any other FtlSpinUp state machine. A subspace conversion file can be intercepted on the public Internet forever, and only the one single FtlSpinUp state machine that generated it will be able to return the data. The subspace converted file contents can only be returned by a customer authorized FtlSpinUp unit, remote or on site. (HERE) option will allow the customer to decide which different FtlSpinUp state machines can, and can not return the subspace conversion file. The factory has all customer signature data, and can be reconstructed in case of emergency.

Communication:

FtlSpinUp subspace converted files are naturally coded to specific FtlSpinUp units only, and the customer decides what if any remote FtlSpinUp units can return the file. FtlSpinUp subspace converted files are naturally secured without external encryption, and can be placed on the open unsecured Internet with millions of unauthorized intercepted copies made, and no copy can be returned without the customer specified authorized FtlSpinUp unit anywhere on planet earth.

FTLDCI Faster Than Light Data Center Interconnect is the option that allows communication with subspace conversion files between different FtlSpinUp state machines typically located in the same Data Center, or at great distances from each other.

The reduced file size is a natural efficiency boost for any existing data communication link. The existing communication link with no modifications will achieve a (2^{26}) increase in both capacity and speed between the two FtlSpinUp state machines, or storage to storage with subspace conversion occurring later.

Data communication performance at (2^{26}) :1 achieved has: 99.999,998,509,883,880,615,234,375 % Efficiency.

Data communication performance at (2^{52}) :1 achieved has: 99.999,999,999,999,977,795,539,574...% Efficiency.

1 bit remains light speed. For every single 1 bit transmitted over fiber optics, or any physical transmission system running at the speed of light, (2^{26}) another 67,108,863 bits will also arrive at the same exact time. At (2^{52}) another 4,503,599,627,370,495 bits will also arrive at the same exact time.

Data Security

(2^{26}) = 67,108,863 bits or
 (2^{52}) = 4,503,599,627,370,495 bits are missing for each bit transmitted, making interception of communications a waste of time, and effort. The missing bits can possibly be seen with a crystal ball, however the amount of crystal balls required is enormous, and time consuming.

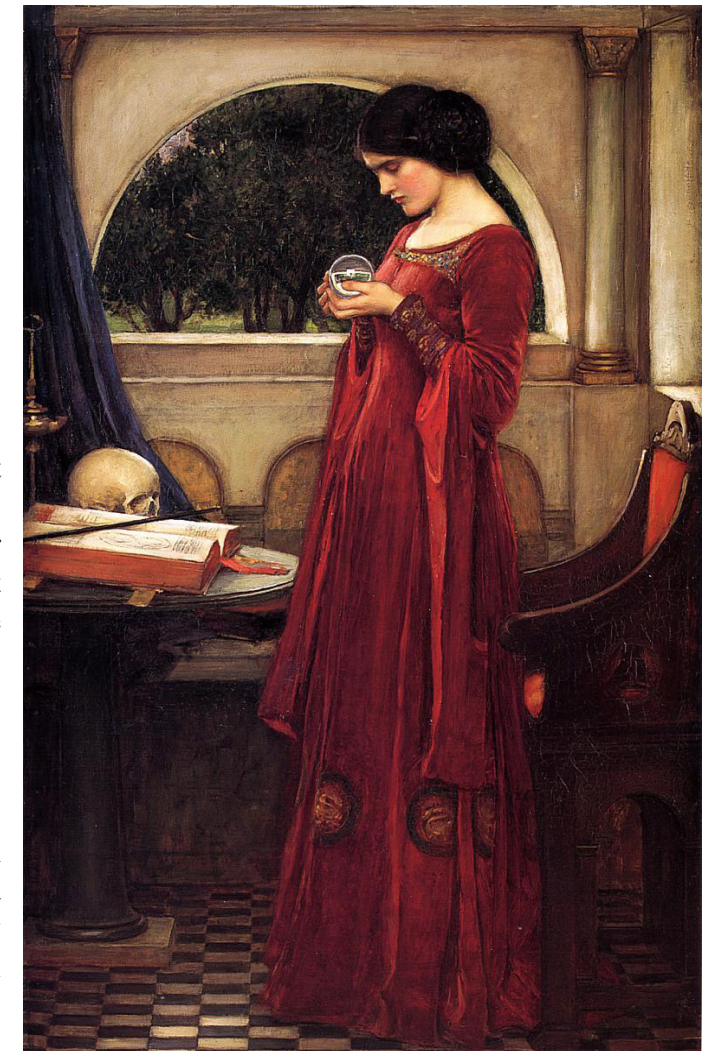



FtlSpinUp is a Codex Grandeur LLC product, that in no way, shape, or form is connected to the SpaceX, or Starlink Corporation. The Starlink services and hardware are not modified in any way, shape, or form. This is an optional purchase by the customer

FtlSpinUp **ONLY WORKS** with FtlSpinUp data. One, two or more FtlSpinUp computers can be linked together with customer permission using Starlink business services. The FtlSpinUp allows up to 2.684 Peta bits per second over the common 10Mbs Uplink, and 10Mbs Downlink. Excessive service charges are not required.

Only the Uplink speed is ever used for FtlSpinUp data transfer
Starlink is NOT INCLUDED in FtlSpinUp - Optional Only

Starlink is used to demonstrate the low bits per second requirement of FtlSpinUp. Any reliable low speed Internet link will work, at a multiple of that available bit rate.



Business Priority Package Starlink
For 1 or 2 Customer Authorized FtlSpinUp Units Only
No modification to SpaceX or Starlink hardware
No signal modification in any way, shape, or form

Near Real-Time
FtlSpinUp Live Data Performance:
Starlink Uplink / Starlink Downlink
Maximum Continuous Bits per Second
Full Duplex / Half Duplex

150 bps Up	FDX Near Real-Time x (2²⁶) = 10 GbE
150 bps Down	FDX Near Real-Time x (2²⁶) = 10 GbE
373 bps Up	HDX Near Real-Time x (2²⁶) = 25 GbE
373 bps Down	HDX Near Real-Time x (2²⁶) = 25 GbE

Local Database File Real-Time Starlink Example
FtlSpinUp 18PB Cartridge (2²⁶) Data Performance:
[44Mbs] Starlink Uplink / [44Mbs] Downlink
Maximum Continuous Bits per Second Full Duplex
One 18PB Cartridge Transmission = ~62 Seconds

44Mbs uplink	x (2²⁶) = 2.9 PbE
44Mbs downlink	x (2²⁶) = 2.9 PbE

Starlink

Business Priority

HIGH SPEED INTERNET DESIGNED FOR BUSINESS

<p>LOCAL PRIORITY 50GB</p> <p>Best for back-up connectivity and small businesses</p> <p>\$65 /MO</p>	<p>LOCAL PRIORITY 500GB</p> <p>Best for small businesses with below average bandwidth needs, e.g. 2-4 users</p> <p>\$165 /MO</p>	<p>LOCAL PRIORITY 1TB</p> <p>Best for small and midsize businesses with average bandwidth needs, e.g. 5-10 users</p> <p>\$290 /MO</p>	<p>LOCAL PRIORITY 2TB</p> <p>Best for midsize businesses with above average bandwidth needs, e.g. 10-20 users</p> <p>\$540 /MO</p>
--	--	---	--

Single Country Land Use and Regional Travel Network Priority Reliable Fixed & In-motion Use Public IP & Dashboard

Expected speeds per Service Plan:

SERVICE PLAN	RESIDENTIAL LITE (FIXED)	RESIDENTIAL 100 MBPS (FIXED)	RESIDENTIAL (FIXED)	ROAM 10GB or 50GB and PAUSE (MOBILITY)	ROAM UNLIMITED (MOBILITY)	PRIORITY
AVAILABILITY	≥99%	≥99%	≥99%	≥99%	≥99%	≥99%
DOWNLOAD	80-200 Mbps	80-100 Mbps	Click For Download Speeds	65-260 Mbps	65-260 Mbps	135-310 Mbps
UPLOAD	15-35 Mbps	15-35 Mbps	Click For Upload Speeds	15-35 Mbps	15-35 Mbps	20-44 Mbps
LATENCY*	Click For Latency	Click For Latency	Click For Latency	Click For Latency	Click For Latency	Click For Latency

*Standby Mode, where available, offers speeds up to 500 Kbps download and upload. *Customers in certain remote locations will experience higher latency (e.g. Oceans, Islands, Antarctica, Alaska, Northern Canada, etc.)

FtlSpinUp uses the Starlink Business Priority service to only send FtlSpinUp data. No general purpose Internet data is supported, other than customer required transactions.

FtlSpinUp can connect to remote Cloud Storage locations. The FtlSpinUp file system can only be recovered by customer authorized FtlSpinUp systems, and the factory. Typically FtlSpinUp products send local storage data back to the factory, where the data is permanently stored in triplicate, in different locations, and never erased, or lost.

The local disk data is considered temporary, and only 100% guaranteed for 200 years plus when sent back to the factory. The local 72PB cartridge data is retention guaranteed for 200 years, however it is not 100% guaranteed for 200 years or more until sent back to the factory.

A completely full 72PB data cartridge with the equivalent of 1,800 40TB tapes, or 2,402 30TB Disks costing \$2,041,700 dollars can be sent back to the factory over Starlink at 44Mbps in just over 1 minute. It may take years for the customer to fill up one 72PB data cartridge.

At 44Mbs Starlink upload speed the 72PB data cartridge was just sent at **~11.811Peta bps** in 62 seconds.

Local disk storage is also sent back to the factory, and 100% guaranteed for 200 years plus. File status will indicate when the 100% guarantee is achieved. Until then the file is single source, and vulnerable to loss.

The \$1,200 every year provides access to the 100% guarantee for 200 years plus at the factory. This removes the requirement for tens of millions of dollars in local storage, and triple redundancy on top of that.

Customers can also purchase an M-Disc library of all their files at any time.

Starlink is one option only, and almost any local medium speed Internet service will work, if available. Typically the Starlink Business Priority customer will not use more than the \$65 dollar service per month.

One possible application is where a 25Gbps camera using the Canon LI-8020SAC imager with lossless pixel data for image analysis, is connected to another FtlSpinUp unit with another Starlink package or local Internet service for a Near Real-Time image from the west coast to the east coast running 24 hours every single day. At that rate of Starlink service, the \$65 would be increased to \$165 per month.

It is possible to store the 25Gbps camera using the Canon LI8020SAC imager with lossless pixel data for image analysis on one FtlSpinUp local disk, and send periodic files back to the factory for 100% guaranteed for 200 years plus storage, and or send to other customer authorized FtlSpinUp units.

(Head Lines)

**All Data is located on Your Desk
All Hardware is at Customer Locations Only**

**Or Send Customer Data to
Another Customer Authorized FtlSpinUp at
10GbE Near Real-Time FDX at 150 bps E
25GbE Near Real-Time HDX at 373 bps E**

Stored (2²⁶) Data over 1GbE = 67.108PbE

**Or Optional Business Package Starlink to
Another Customer Authorized FtlSpinUp at
10GbE Near Real-Time Full Duplex
~1,000,000,000 Bytes per second
25GbE Near Real-Time Half Duplex
~2,500,000,000 Bytes per second**

Stored (2²⁶) Data over 44Mbs = 2.9PbE

**Or Local Fiber Optics
For Customer Authorized FtlSpinUp Units Only**

**Or Any Reliable Data Communications
For Customer Authorized FtlSpinUp Units Only**

100% Mathematical Lossless Customer Data

**All FtlSpinUp Data Can Be Stored on
200 Year Data Retention 18PB Cartridges
1,000 Year Optical Discs**

(Head Lines)

**Deep Freezer for All Actions and Data Storage
For Emergency Use Only if everything fails
100% Recovery Return for Life Guaranteed
Only if Deep Freezer Data sent to Factory**

**All Raw Data is Subspace Converted at Input
No Raw Data Stored Anywhere in FtlSpinUp
Lossless Subspace Data Returned at Output**

**FtlSpinUp Header Used for Raw Data Blocks
No Analysis of Raw Data Content - No Internet**

**Raw Data Block Hash Codes - FtlSpinUp Header
Guaranteed Raw Data Block Integrity At Input**

Raw Data Block Hash Codes Returned at Output

**Near Real-Time Random Access Read and Write
From Computer at 10GbE FDX, and 25GbE HDX**

**Deep Freeze of All Actions and Data
For Emergency Use Only Possible by Customer**

**100% Recovery Return for Life
When Deep Freeze Copy sent to Factory**

**All FtlSpinUp Data Can Be Stored on
1,000 Year Optical Discs**

**Each and Every FtlSpinUp Unit is Original ART
Customer Authorized Remote Units Only**



Pay as You Go Pricing

\$71,600 per month

\$859,200 per year

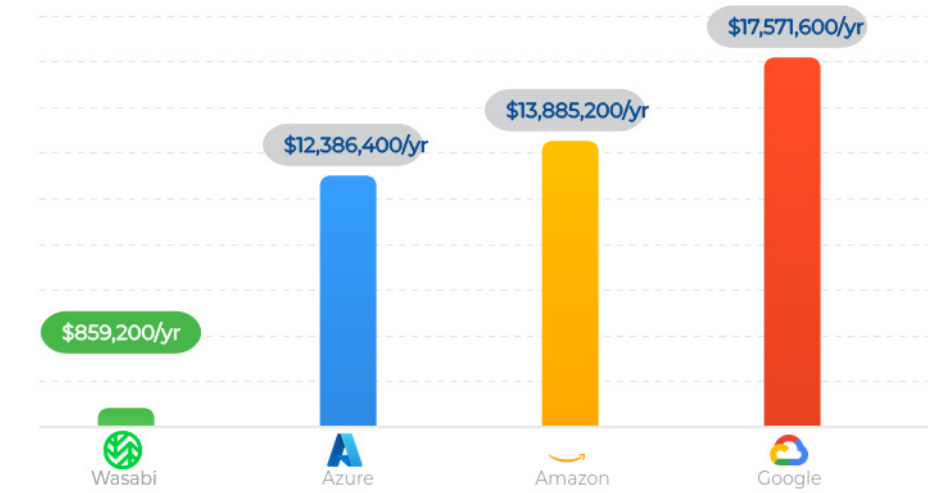

STORAGE AMOUNT



PERCENT DOWNLOAD PER MONTH



Backblaze Products Solutions Pricing Resources Why Backblaze [Contact Sales](#) [Start Free](#)

Total Data Stored: 10000 TB Monthly Downloads: 10000 TB

Backblaze B2	\$720,000/yr
aws s3	\$8,932,200/yr
Microsoft Azure	\$7,150,080/yr
Google Cloud	\$12,363,720/yr

*Up to 3x of average monthly data stored, then \$0.01/GB for additional egress
This chart features published rates for the U.S. West region. Backblaze competitors' rates can vary by region, amount stored, and other factors. View API call rate details [here](#).



64 files at 22,528 Bytes each
 512 Bytes for sha512sum - Index
 22,016 Bytes for Data Storage
 22,016 Bytes X (2^26) =
 1,477,468,749,824 Bytes or
 1.477 Tera Bytes
 X 64 files =
 94,557,999,988,736 Bytes or
 94.557 Tera Bytes
 Divided by 40TB LTO-10 =
 2.363 Tapes

One Single 1.44 diskette holds over two 40TB LTO-10 Tapes
 Of previous compressed video storage, programs, and data

Starlink UpLink is now rated at 44 Million bits per second MAX
 Actual available may be half or 22 Million bits per second

LTO-10 40TB Tapes are NOT REQUIRED for FtISpinUp
 and used for comparason ONLY.



USA TERRITORIES ONLY



USA TERRITORIES ONLY

FtISpinUp (1)

FtISpinUp (2)



1.44MB / 4.4MBs UpLink
44Mbs = 0.327 Seconds
22Mbs = 0.654 Seconds



80TB / 4.4MBs UpLink
44Mbs = 210.437 Days
22Mbs = 1.152 Years



SYMPPLY SymplyPRO XTF Thunderbolt
 LTO-10 Desktop Tape Drive

BH # SYPRODT3LAF1 MFR # SYPRO-DT3LAF1B-AT

Key Features

- 1 x Full-Height LTO-10 Tape Drive
- Thunderbolt 3 Host Interface
- 12 Gb/s SFF-8644 Expansion Port
- Native Transfer Speeds up to 400 MB/s

\$12,349⁰⁵

12 Mos. Promo Financing with Payboo⁵

Add to Cart

Special Order

Expected availability: 4-6 Weeks

Free Standard Shipping

MagStor
 Fujifilm LTO-10 Ultrium 40TB Data
 Cartridge LTO10 16978170

~~\$ 888.89~~
\$ 499.99

- 1 +

Add to Cart

Share

Pickup Available At 7100 Huntley Rd.
 View Store Details



Typical 12 Disk SATA NAS Reference [Reference Only]

**NAS Electronics Box
12 Disk
(Not Included)
Two 10GbE Interface
\$400 - \$2,000**

**Possible 5 Year Disk
Data Retention
Nvme SSD
Possible 2 year
Data Retention**

[Compare Options](#)



Option: 30TB Exos M

24TB Exos X24 \$624.45	22TB Exos X22 \$512.10	20TB Exos X20 \$490.70
18TB Exos X18 \$474.45	16TB Exos X18 \$474.45	14TB Exos X18 \$339.99
10TB Exos X16 \$374.45	30TB Exos M \$850.00	

- Scalable hyperscale applications/cloud data centers
- Massive scale-out data centers
- Big-data applications
- High-capacity density RAID storage
- Mainstream enterprise external storage arrays
- Distributed file systems, including Hadoop and Ceph
- Enterprise backup and restore—D2D, virtual tape

12 Disk x \$850 = \$10,200 + \$2,000 = \$12,200

360TB / 40TB Tapes = 9 LTO 40TB Tapes

Peak Maximum 360TB with NO BACKUP

No Continuous Data Security

Not Included OPTIONS:

FtlSpinUp Desktop sized Computer



**Nvidia NIC two 100GbE or 200GbE
100GbE Full Duplex Near Real-Time
200GbE Half Duplex Near Real-Time
One 30TB Disk with Customer Storage**

FtlSpinUp Internal Disk 1,342,177,280,000,000,000,000
10GbE FDX-25GbE HDX Zetta Exa Peta Tera Giga Mega Kilo Hecto

\$40,000 Dollars **1Time** **Hardware Included**
\$1,200 Dollars **Every Year** **Factory Triple Backup**

**Zip files are entered into FtlSpinUp up to
90TB blocks that require 1.44 MB each on the
30TB Disk Drive. The 1.44 MB files are sent back
to the factory for triple redundancy 100% Guar-
anteed return, and never erased. A simple email
is used, and a return email for green light receipt.**

**Automatic sha512sum checksum bits are used
throughout the entire 1.44 MB file to ensure data
communication integrity.**

**The 1.44MB file will fit onto a diskette, however it
does not have any limitations as to storage media.**

FtlSpinUp
AMD EPYC 9965

192 Cores

2 Fiber Optic - 100GbE / 200GbE

**Factory Triple Redundant Automated Backup
100% Guaranteed Data Sent to Factory**

90TB sent to any NAS at 10GbE is 25 Hours
90TB returned to any NAS at 10GbE is 25 Hours
Actual time may be greater depending on Disk Drive Array

90TB sent to any NAS at 25GbE is 10 Hours
90TB returned to any NAS at 25GbE is 10 Hours
Actual time may be greater depending on Disk Drive Array

**90TB sent with Starlink 22Mbs Uplink (No FtlSpinUp)
is 1.425 Years**
**90TB returned with Starlink 22Mbs Uplink (No FtlSpinUp)
is 1.425 Years**

FtlSpinUp Demo 60GB File at 200GbE is 3 Seconds

FtlSpinUp is Full Duplex 100GbE
3,728,270 Times More Storage than 360TB NAS
90TB sent to FtlSpinUp at 100GbE is 2.5 Hours
Only 1.44MB is used to store the 90TB
1.44MB returned from FtlSpinUp at 100GbE is 2.5 Hours
1.44MB is separated into 64 individual segments

FtlSpinUp is Half Duplex 200GbE
3,728,270 Times More Storage than 360TB NAS
90TB sent to FtlSpinUp at 200GbE is 1.25 Hours
Only 1.44MB is used to store the 90TB
1.44MB returned from FtlSpinUp at 200GbE is 1.25 Hours
1.44MB is separated into 64 individual segments

CargoBit (1Million Dollars+) is HDX 4 Tera bit Ethernet
90TB sent to Cargobit at 4TbE is 3.75 Minutes
Only 1.44MB is used to store the 90TB
1.44MB returned from FtlSpinUp at 4TbE is 3.75 Minutes
1.44MB is separated into 64 individual segments

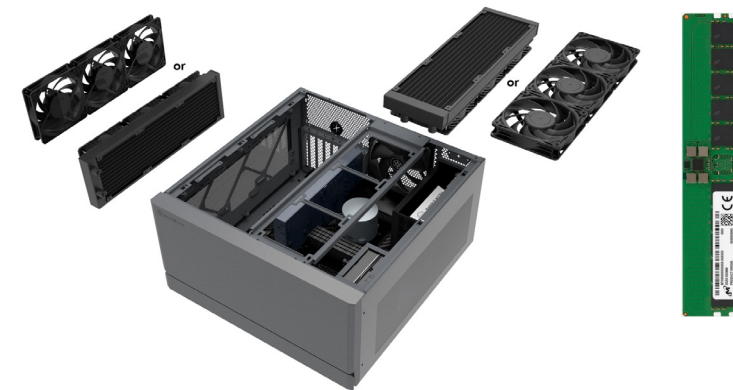
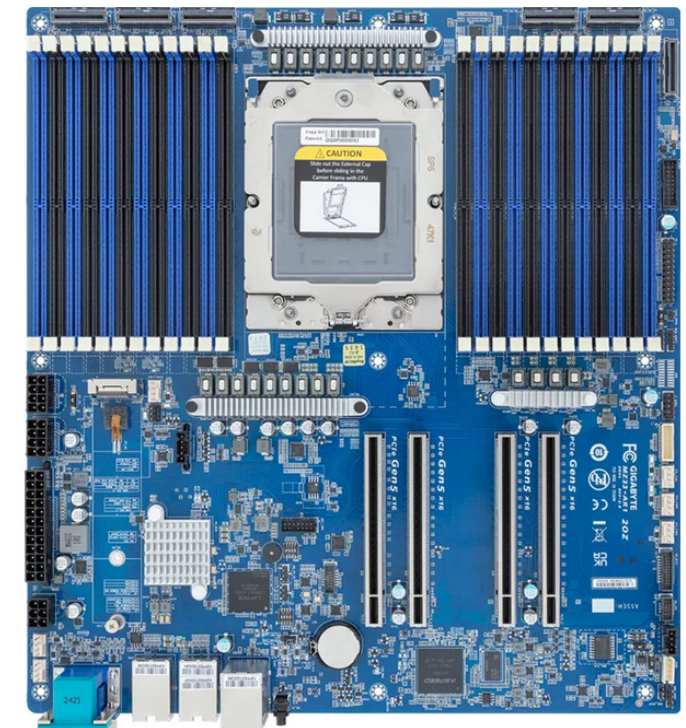
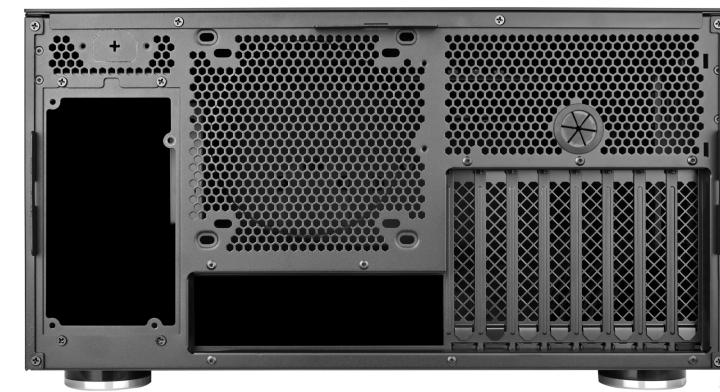
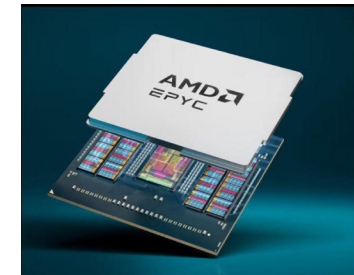

FtlSpinUp
AMD EPYC 9965 192 Cores
2 QSFP 200GbE / 200GbE

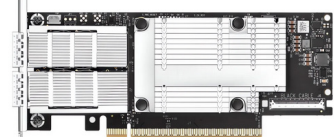

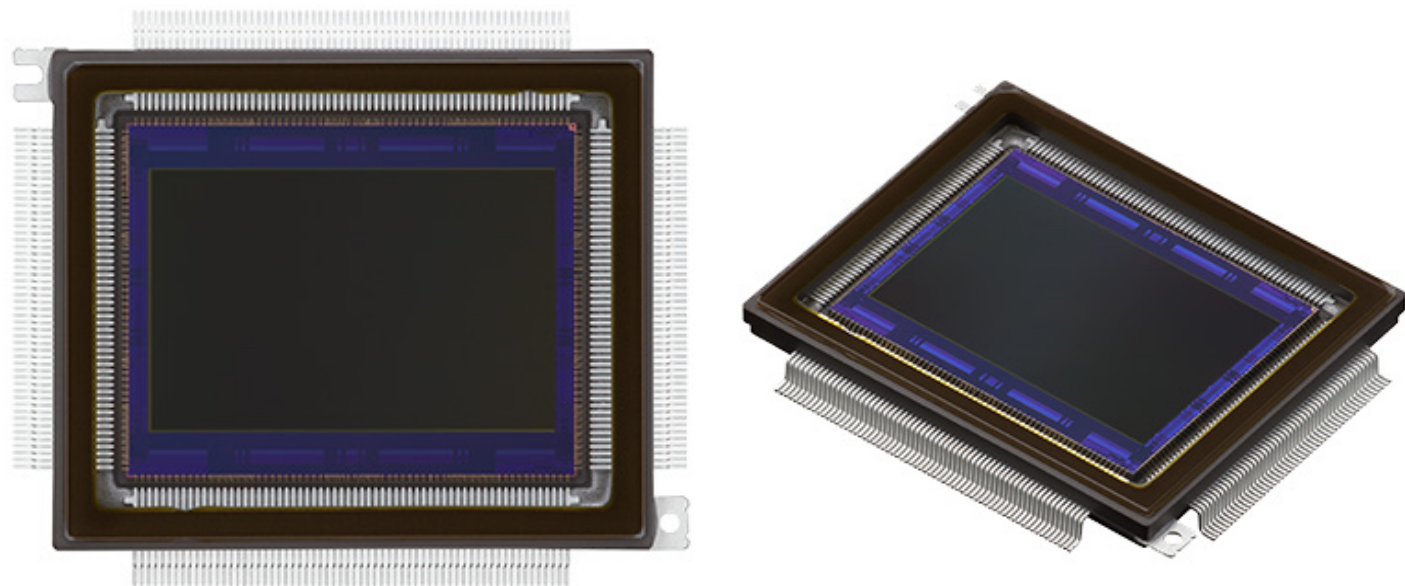

4900C002

DigiKey Part Number: 2157-4900C002-ND
 Manufacturer: Canon
 Manufacturer Product Number: 4900C002
 Description: LI8020SAC
 Manufacturer Standard Lead Time: 6 Weeks
 Customer Reference:
 Detailed Description: Image Sensor
 Datasheet: [Datasheet](#)

In-Stock: 1

[Check for Additional Incoming Stock](#)

QUANTITY:

[Add to List](#) [Add to Cart](#)

All prices are in USD

QUANTITY	UNIT PRICE	EXT PRICE
1	\$14,131.25000	\$14,131.25

Manufacturers Standard Package

Note: Due to DigiKey value-add services the packaging type may change when product is purchased at quantities beneath the standard package.

Canon LI8020SAC
(Lima India 8020 Sierra Alpha Charlie)
19568 x 12588 (Horizontal x Vertical)
34.9mm Diagonal 246MP CMOS Sensor on 228pin QFP / 2.304 m Square Pixels at 5.0fps



8 Camera Sensors / 25GbE each = 200GbE Input
24 hours per day Lossless Pixel Storage / Transmission

FtISpinUp Internal Disk 1,342,177,280,000,000,000,000
 10GbE FDX-25GbE HDX Zetta Exa Peta Tera Giga Mega Kilo Hecto

2,126 Years of Continuous 24 hour Storage / Transmission
Simultaneous Triple Redundant Storage sent to Factory

100% Guaranteed Triple Redundant Data Backup

(Maximum Data Rate in bits per second)
(19568 X 12588) X (12 bits per pixel) X (5.0 Frames per second) =
14,779,319,040 bits per second = 14.779319040 Giga bits per second
Easily fits into one standard 25GbE Fiber Optic Cable

(8)-25GbE Fiber Optic Camera can be supported in Near Real-Time
With one FtISpinUp System storing Centuries of Lossless Camera Detail
Possible to transmit Camera Starlink (A) to another
Starlink FtISpinUp System at Location (B) in Near Real-Time
Please see the 4 minute Canon Video:

<https://youtu.be/3ND210j4EIM?si=HspsorYzCeSHV0J9>
[Possible Application]

FtlSpinUp Desktop sized Computer



**Nvidia NIC 200GbE / 400GbE
200GbE Full Duplex Near Real-Time
400GbE Half Duplex Near Real-Time
One 30TB Disk with Customer Storage**

FtlSpinUp Internal Disk 1,342,177,280,000,000,000,000
10GbE FDX-25GbE HDX Zetta Exa Peta Tera Giga Mega Kilo Hecto

\$70,000 Dollars **1Time** **Hardware Included**
\$2,4000 Dollars **Every Year** **Factory Triple Backup**

Zip files are entered into FtlSpinUp up to 90TB blocks that require 1.44 MB each on the 30TB Disk Drive. The 1.44 MB files are sent back to the factory for triple redundancy 100% Guaranteed return, and never erased. A simple email is used, and a return email for green light receipt.

Automatic sha512sum checksum bits are used throughout the entire 1.44 MB file to ensure data communication integrity.

The 1.44MB file will fit onto a diskette, however it does not have any limitations as to storage media.

FtlSpinUp

Two AMD EPYC 9965

192 Cores + 192 Cores

1 Fiber Optic - 100GbE / 200GbE / 400GbE

**Factory Triple Redundant Automated Backup
100% Guaranteed Data Sent to Factory**

90TB sent to any NAS at 10GbE is 25 Hours
90TB returned to any NAS at 10GbE is 25 Hours
Actual time may be greater depending on Disk Drive Array

90TB sent to any NAS at 25GbE is 10 Hours
90TB returned to any NAS at 25GbE is 10 Hours
Actual time may be greater depending on Disk Drive Array

90TB sent with Starlink 22Mbs Uplink (No FtlSpinUp) is 1.425 Years
90TB returned with Starlink 22Mbs Uplink (No FtlSpinUp) is 1.425 Years

FtlSpinUp Demo 60GB File at 400GbE is 1.5 Seconds

FtlSpinUp is Full Duplex 200GbE
3,728,270 Times More Storage than 360TB NAS
90TB sent to FtlSpinUp at 200GbE is 1.25 Hours
Only 1.44MB is used to store the 90TB
1.44MB returned from FtlSpinUp at 200GbE is 1.25 Hours
1.44MB is separated into 64 individual segments

FtlSpinUp is Half Duplex 400GbE
3,728,270 Times More Storage than 360TB NAS
90TB sent to FtlSpinUp at 400GbE is 37.5 Minutes
Only 1.44MB is used to store the 90TB
1.44MB returned from FtlSpinUp at 400GbE is 37.5 Min.
1.44MB is separated into 64 individual segments

CargoBit (1Million Dollars+) is HDX 4 Tera bit Ethernet
90TB sent to Cargobit at 4TbE is 3.75 Minutes
Only 1.44MB is used to store the 90TB
1.44MB returned from FtlSpinUp at 4TbE is 3.75 Minutes
1.44MB is separated into 64 individual segments

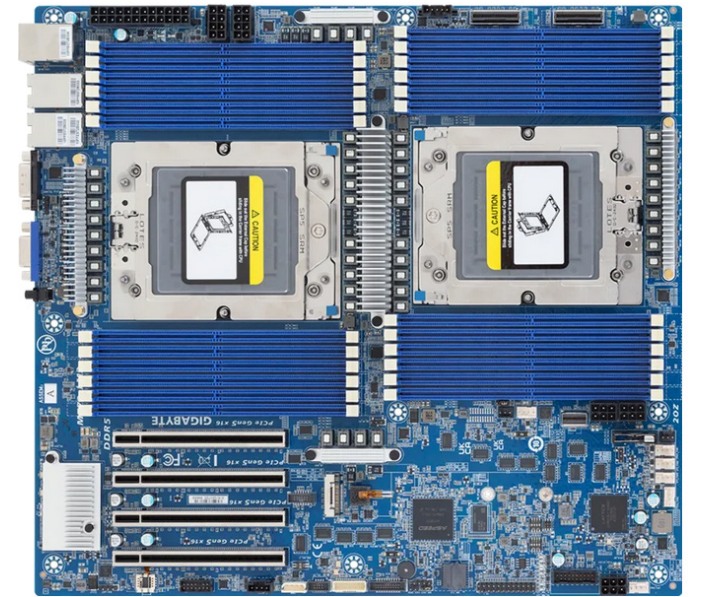
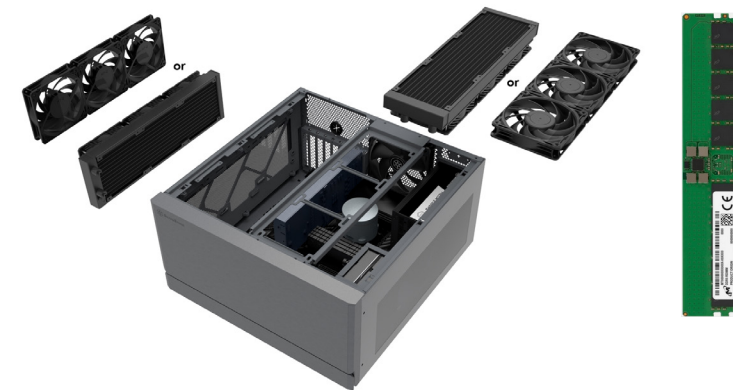
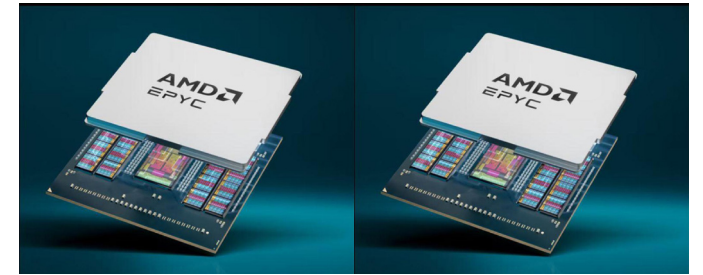
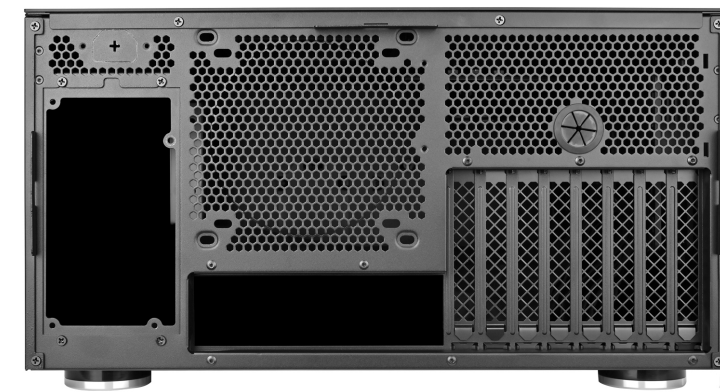

FtlSpinUp
2 AMD EPYC 9965 192 + 192
1 QSFP 400GbE

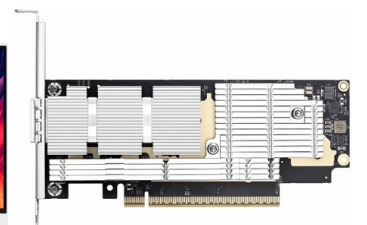
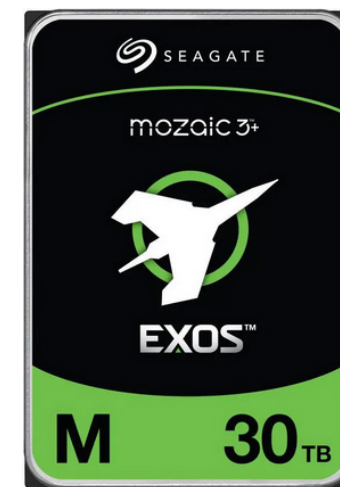

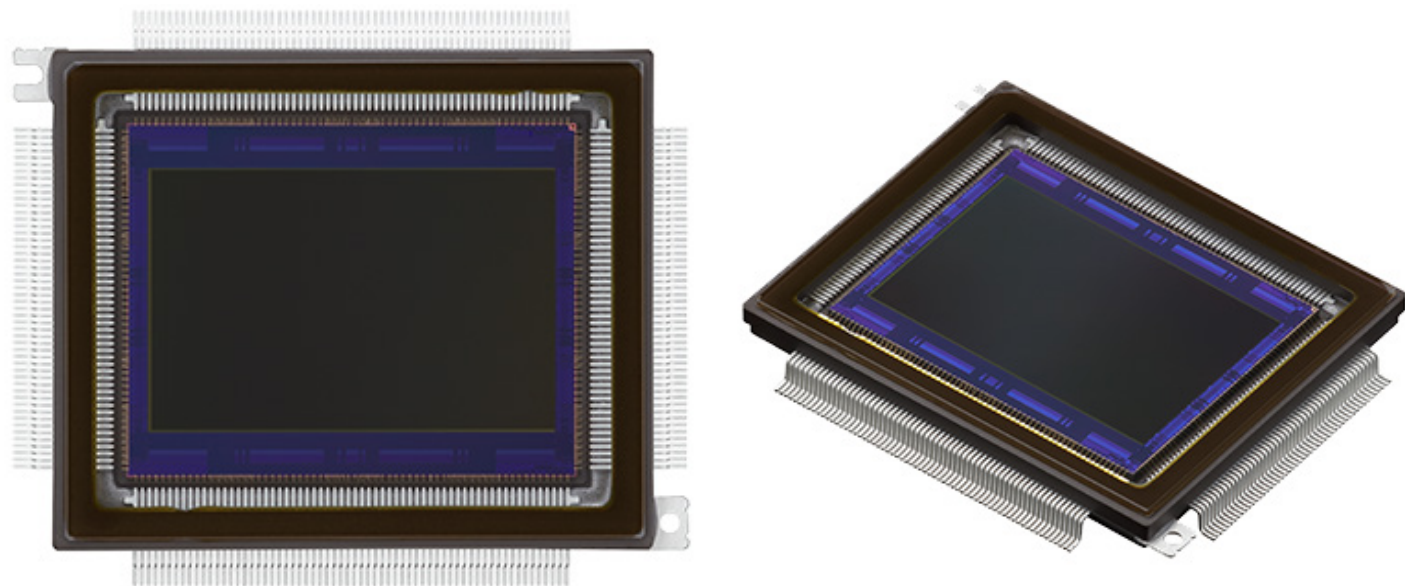

4900C002

DigiKey Part Number: 2157-4900C002-ND
 Manufacturer: Canon
 Manufacturer Product Number: 4900C002
 Description: LI8020SAC
 Manufacturer Standard Lead Time: 6 Weeks
 Customer Reference:
 Detailed Description: Image Sensor
 Datasheet: [Datasheet](#)

In-Stock: 1

[Check for Additional Incoming Stock](#)

QUANTITY:

[Add to List](#) [Add to Cart](#)

All prices are in USD

Tray

QUANTITY	UNIT PRICE	EXT PRICE
1	\$14,131.25000	\$14,131.25

Manufacturers Standard Package

Note: Due to DigiKey value-add services the packaging type may change when product is purchased at quantities beneath the standard package.

Product Attributes

TYPE	DESCRIPTION	SELECT ALL
	Sensors Transmitters	<input type="checkbox"/>

**Canon
LI8020SAC
(Lima India 8020 Sierra Alpha Charlie)
19568 x 12588 (Horizontal x Vertical)**

34.9mm Diagonal 246MP CMOS Sensor on 228pin QFP / 2.304 m Square Pixels at 5.0fps

(Maximum Data Rate in bits per second)

**(19568 X 12588) X (12 bits per pixel) X (5.0 Frames per second) =
14,779,319,040 bits per second = 14.779319040 Giga bits per second
Easily fits into one standard 25GbE Fiber Optic Cable**

**(16)-25GbE Fiber Optic Camera can be supported in Near Real-Time
With one FtISpinUp System storing Centuries of Lossless Camera Detail**

**Possible to transmit Camera Starlink (A) to another
Starlink FtISpinUp System at Location (B) in Near Real-Time**

Please see the 4 minute Canon Video:

<https://youtu.be/3ND210j4EIM?si=HspsorYzCeSHV0J9>

[Possible Application]

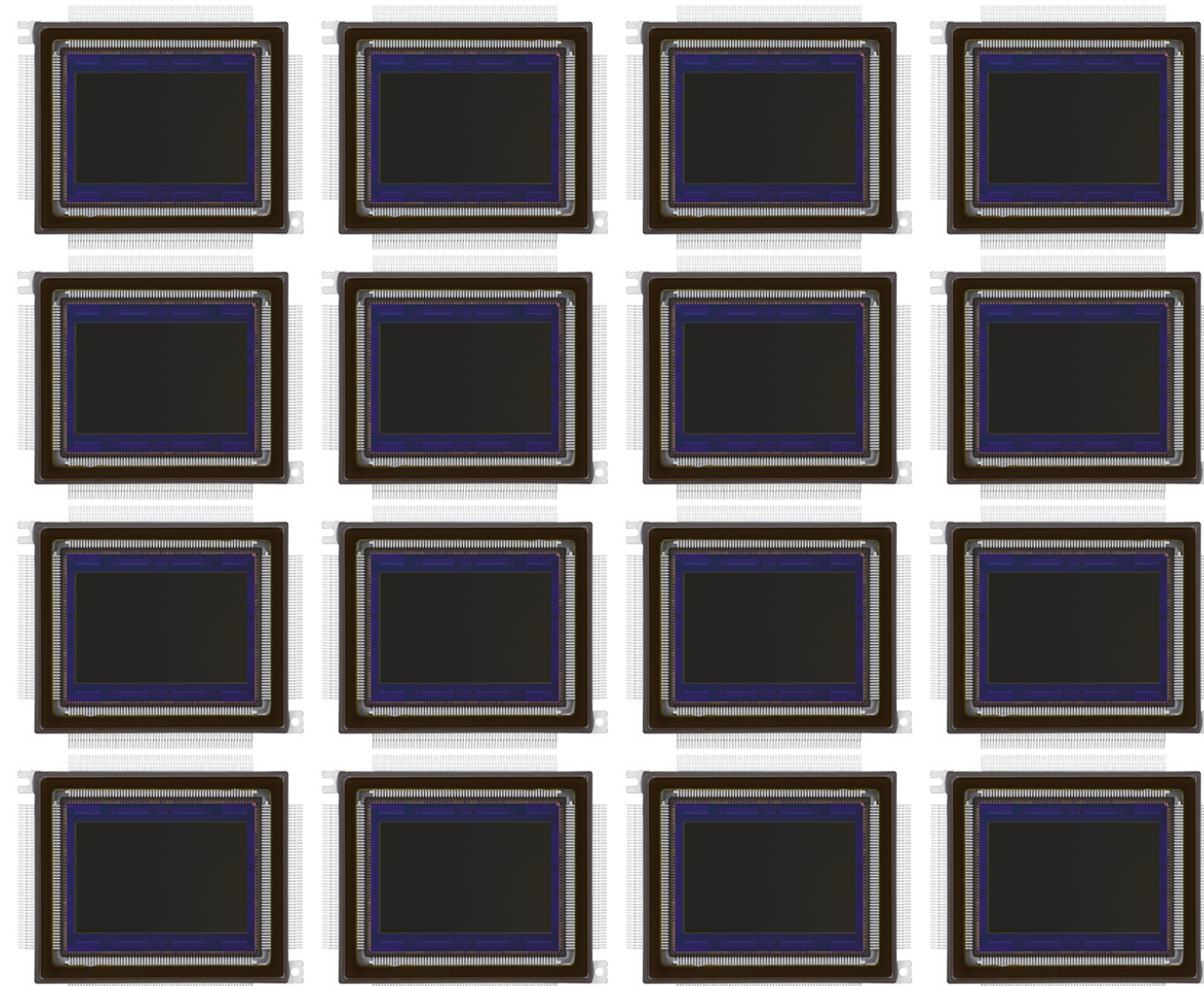

16 Camera Sensors / 25GbE each = 400GbE Input

24 hours per day Lossless Pixel Storage / Transmission

FtISpinUp Internal Disk 1,342,177,280,000,000,000,000
10GbE FDX-25GbE HDX Zetta Exa Peta Tera Giga Mega Kilo Hecto

1,063 Years of Continuous 24 hour Storage / Transmission

Simultaneous Triple Redundant Storage sent to Factory

100% Guaranteed Triple Redundant Data Backup



OPTION = Data, Dataset, Database Formatting

Data are observations or measurements (unprocessed or processed) represented as text, numbers, or multimedia.

A **Dataset** is a structured collection of data generally associated with a unique body of work.

A **Database** is an organized collection of data stored as multiple datasets. Those datasets are generally stored and accessed electronically from a computer system that allows the data to be easily accessed, manipulated, and updated. **www.usgs.gov reference = USGS**

Customer **OPTIONAL** formatting is not required, when conventional file systems are used.

OPTIONAL formatting can be manipulated external to FtlSpinUp by remote existing computers. Only the initial subspace conversion and eventual return is required on the FtlSpinUp machine. Usage of the Ram Disk magnified from (2^{26}) can optionally be used in the form of extreme detail expansion, being the opposite to data storage efficiency. The conceptual model on Page 24 represents a structural housing containing the data array. The planar surfaces of the housing represent electrical interconnection socket panels providing data paths to the data array. One single housing is one single Element.

The Data, Dataset, and Database can be dynamically formatted with a vernier fine grain, to a coarse grain supporting custom Data, Dataset, and Database architectures. Vernier fine grain will use the most number of bytes, and provide the most multidimensional interconnected dynamic detail supporting optimal analysis, and work. Coarse grain is typical of current Database formatting designed for optimal byte storage efficiency.

Each conceptual model Element has 14 direct connection planar surfaces used for communication switching between different Elements in the array of multiple Elements. The 14 direct connection surfaces have 8 switchable positions for each separate Element. High frequency electrical switching between different Elements allows dynamic reconfigurations without computation of any kind. The constituent fine grain component factors that are customer defined inside of each Element are dynamic also, however with some computation required for location reconfiguration.

FtlSpinUp numerical multidimensional interconnected geometric array of Elements can be static or dynamic. FtlSpinUp has the customer option of dynamic constructions, where the Database is configured with customer input for optimized long distance fiber optic communications, and Dell computer architecture ability for diverse, multidimensional and dynamic numerical interconnection of Element arrays used in machine intelligence, machine vision, and pattern analysis.

Each element also has its own unique Database that is both local, and global to authorized customer elements. Additional bytes are used for checksum, ECC, and Database formatting, with proprietary overhead not involved in the direct customer usable data count. The customer byte count and actual byte count used for checksum, ECC, and Database formatting through the FtlSpinUp application program interface, both automatic, and customer programmable will be different. FtlSpinUp proprietary overhead is invisible to the customer, and not involved in any data communications. No additional charge is applied for the FtlSpinUp Element Database, or proprietary overhead, and is considered a unique FtlSpinUp feature.

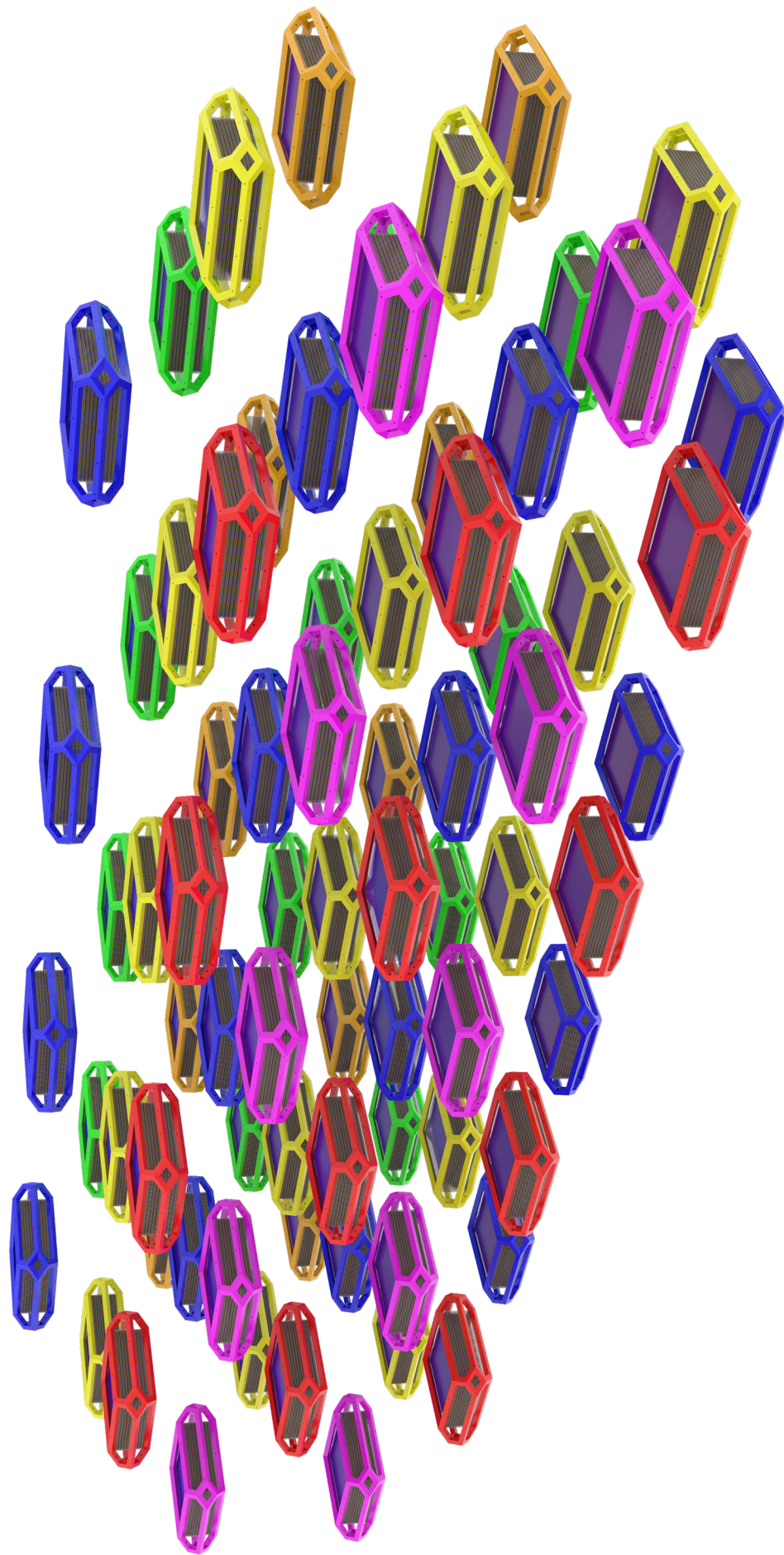

OPTION = Data, Dataset, Database Formatting

Almost all data processing up till now has been concerned with limiting the real world needs to fit the boundary limitations of data storage, time, cost, energy, environment, human cost, buildings, communications, profit margin, and final product. Maximum efficiency with minimum resource allocation, and utilization, will achieve a serious loss of both strategic, and tactical performance.

FtlSpinUp is capable of exploding data detail into permutations, and combinations not practical and low cost until now. The current perspective of data is viewed from the outside-in because of human, and machine limitations. FtlSpinUp can achieve an inside-out perspective on data.

It is now possible to expand data into unlimited components that enhance association, analysis, and generate targeted processing segmentation, while quiet data remains dormant. The constant generation of associative data blocks insure new analysis results. FtlSpinUp compressed data blocks are created, and updated based on desired target characteristics such as video surveillance automobiles of a specific manufacture, color, shape, license, occupants, location, time, are stored in different associative blocks.

Knowledge-Based systems with deductive and inductive inference, and dynamically-reconfigurable systems with software-controlled reconfigurability are given almost unlimited data storage, including complex question-answering: knowledge-based systems with correlation analysis. Simultaneous communication of data among processors with (2^{26}) increase in performance. Lower native 1GbE Ethernet allows multi-dimensional network arrays with very low cost overhead. Actual data throughput is (2^{26}) time 1Gb Ethernet with FtlSpinUp. Of course 25GbE HDX is also multiplied by (2^{26}) with FtlSpinUp.

FtlSpinUp supports very fine grain subspace conversion data blocks eliminating the need for massive scale data storage and retrieval at one time. Every single FtlSpinUp payload section has a very limited non-compressed write-able area for customer usage that allows real time dynamic update of Data Base and Data Set pointers of the (2^{26}) compressed data, so no conversion is required. The (2^{26}) to 1 compression ratio is maintained. Of course a Data Base, and Data Set of pointers can be generated. Individual FtlSpinUp payload sections are independent, and can be maneuvered without destruction of overall compression. Only customer data contained in the individual FtlSpinUp payload section is relocated. Customer formatting of FtlSpinUp payload sections is possible with optional software.

Similar to a very large file that has been compressed with the 7-zip file manager into different files numbering into the hundreds, where every single specific different numbered file has to be available, or the original very large file can not ever be decompressed. FtlSpinUp is just the opposite. The original very large file that has been compressed with FtlSpinUp into specific different files numbering into the hundreds, thousands, or millions, can be decompressed individually. Also the separate individuals, including individuals from different compressed very large files, can be assembled into new creations before decompression.

A very large file that has been compressed with the 7-zip file manager into segmented different files numbering into the hundreds, and every single specific different segmented numbered file has to be available, or the original very large file can not ever be decompressed. FtlSpinUp is just the opposite. The original very large file is subspace converted with FtlSpinUp into specific different files numbering into the hundreds, thousands, or millions, can be decompressed individually. Also the separate individuals, including individuals from different compressed very large files, can be assembled into new creations before decompression.

Random Access Memory 6,710,886,400,000,000,000
Near Real-Time RAM DISK Exa Peta Tera Giga Mega Kilo Hecto

**Content Addressable Random Access Memory
 With Generated Index Tables**

**Two 64GB Ram Modules = 128GB - (28GB for system)
 100GB Ram x (2^26) = 6.710 Exa Byte Near Real-Time**

Additional Larger Local Disk for power down storage

Additional Battery for power down no loss storage support

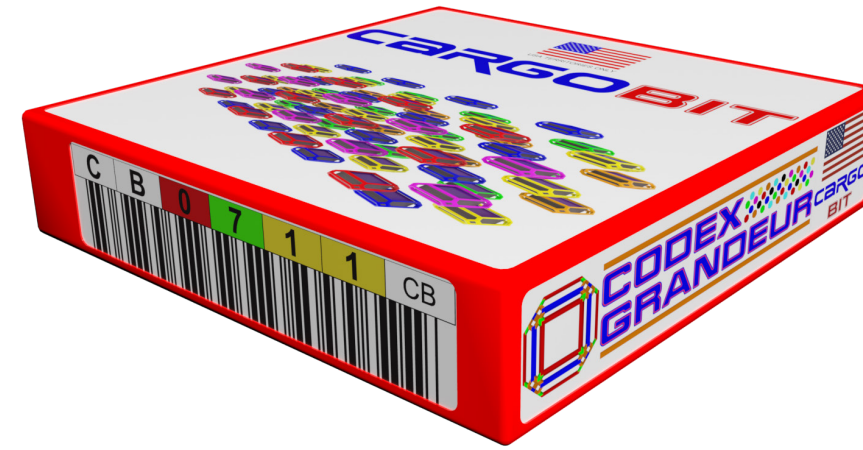
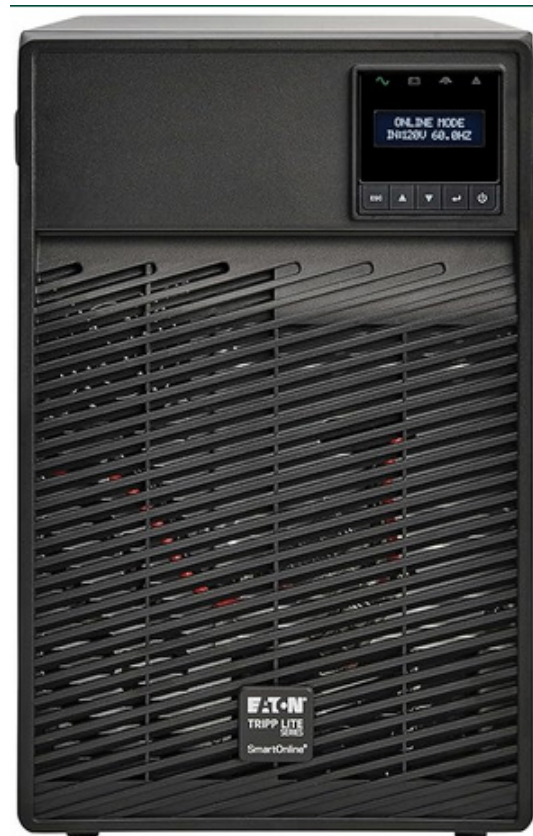
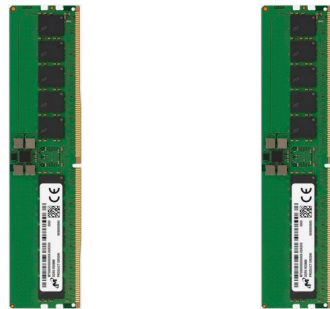

**18 Peta Byte
 200 Yr Retention
 100,000 Cycles
 8 second R/W
 \$256.00 Retail
 FtSpinUp Only
 No Batteries**
 ~ Size of LTO Tape Cartridge

Semiconductor Storage X (2^26) = 18,014,398,509,481,984
 Peta Tera Giga Mega Kilo Hecto

**Existing Native 40TB Tape
 Maximum 400MBs = 1.157 Days Read, 1.157 Days Write**

**FtSpinUp 18 Peta Byte Semiconductor Cartridge
 One Single Cartridge holds 450 Individual 40TB Tapes
 25GbE HDX R/W 40TB = 4.45 Hours Read, 4.45 Hours Write
 10GbE FDX R/W 40TB = 11.12 Hours Simultaneous Read and Write**

**Once Data is Transferred into FtSpinUp System, it is converted to
 (2^26) 67,108,864 Times Smaller, at Near Real-Time Throughput**

No customer raw data is ever stored inside the FtSpinUp. 40TB of Customer data can be transmitted, or received at 10GbE Full Duplex (FDX), or 25GbE Half Duplex (HDX) Near Real-Time, and automatically converted (2^26) onto the internal 30TB Disk, and the 18PB semiconductor cartridge. A recording is also stored into the Deep Freezer.

No customer raw data is ever stored inside the FtSpinUp. 40TB of Customer data can be transmitted, or received at 25GbE Half Duplex and automatically converted at (2^14) onto the internal Raid 60 Disk Array requiring 2.442GB at 4.45 hours. The 2.44GB is then converted another (2^14) to (2^28) in under one second for a total of 149,012 Bytes. The 149,012 Byte total is then formatted and stored onto the FtSpinUp Cartridge in a few seconds.

The procedure is reversed for reading the file back to the 10GbE, or 25GbE.

Only customer authorized FtSpinUp systems are capable of returning any stored data. The FtSpinUp has a secured processor that will not function if moved from the assigned location. Any theft of physical computers to another location will stop the secured processor from working. No other computer system can recover any stored data, other than a different customer authorized FtSpinUp systems, or factory.

Retrieval of a stolen, or destroyed FtSpinUp system storage can be reconstructed at the FtSpinUp factory from previous Deep Freeze backups provided to the factory from the customer Deep Freeze AT&T factory link.

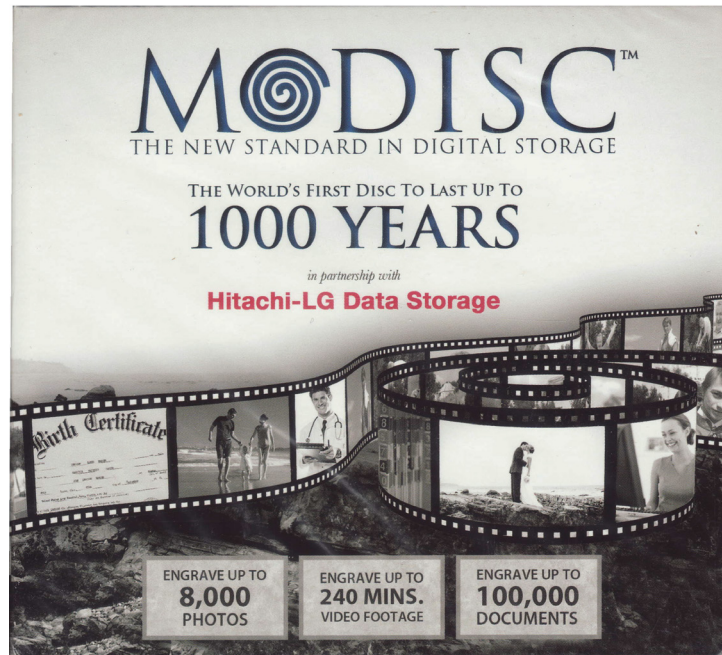

A special subspace conversion is required to reduce the FtlSpinUp data below the raw 100GB BD-XL M-DISC with more processor time required.

The 100GB BD-XL M-DISC is recommended, and any optical disc supported by the drive is usable, and can be multiplied by FtlSpinUp (2^26).

FtlSpinUp has a special internal formatting subspace conversion that takes the original subspace conversion of (2^26) storage data, and has another special subspace conversion, including read after write subspace conversion with hash, and a full bit comparison cycle for a guaranteed return before the burn process begins.

The special conversion formatting allows local storage of Deep Freezer data.

The process is reversed for retrieval of the (2^26) data stored from the one single 100GB BD-XL M-DISC. The special subspace conversion will function at near real-time for the data return from the optical disc drive.

**100GB BD-XL M-DISC (2^26)
Formatting Not Included**

6,710,886,400,000,000,000
Exa Peta Tera Giga Mega Kilo Hecto

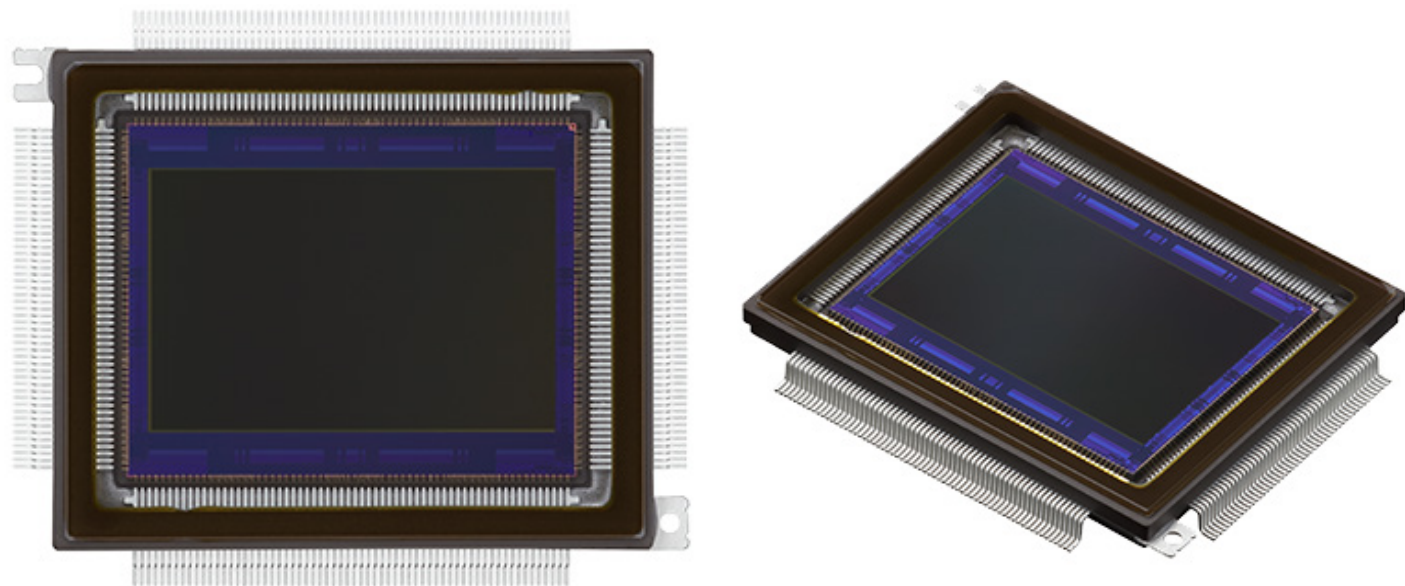

4900C002

DigiKey Part Number: 2157-4900C002-ND
 Manufacturer: Canon
 Manufacturer Product Number: 4900C002
 Description: LI8020SAC
 Manufacturer Standard Lead Time: 6 Weeks
 Customer Reference:
 Detailed Description: Image Sensor
 Datasheet: [Datasheet](#)

In-Stock: 1

[Check for Additional Incoming Stock](#)

QUANTITY:

[Add to List](#) [Add to Cart](#)

All prices are in USD

Tray	QUANTITY	UNIT PRICE	EXT PRICE
1	1	\$14,131.25000	\$14,131.25

Manufacturers Standard Package

Note: Due to DigiKey value-add services the packaging type may change when product is purchased at quantities beneath the standard package.

**Canon
LI8020SAC
(Lima India 8020 Sierra Alpha Charlie)
19568 x 12588 (Horizontal x Vertical)**

34.9mm Diagonal 246MP CMOS Sensor on 228pin QFP / 2.304 m Square Pixels at 5.0fps

**(Maximum Data Rate in bits per second)
(19568 X 12588) X (12 bits per pixel) X (5.0 Frames per second) =
14,779,319,040 bits per second = 14.779319040 Giga bits per second
Easily fits into one standard 25GbE Fiber Optic Cable**

**(1)-25GbE Fiber Optic Camera can be supported in Near Real-Time
With one FtISpinUp System storing Centuries of Lossless Camera Detail
Possible to transmit Camera Starlink (A) to another
Starlink FtISpinUp System at Location (B) in Near Real-Time
Please see the 4 minute Canon Video:**

<https://youtu.be/3ND210j4EIM?si=HspsorYzCeSHV0J9>
[Possible Application]

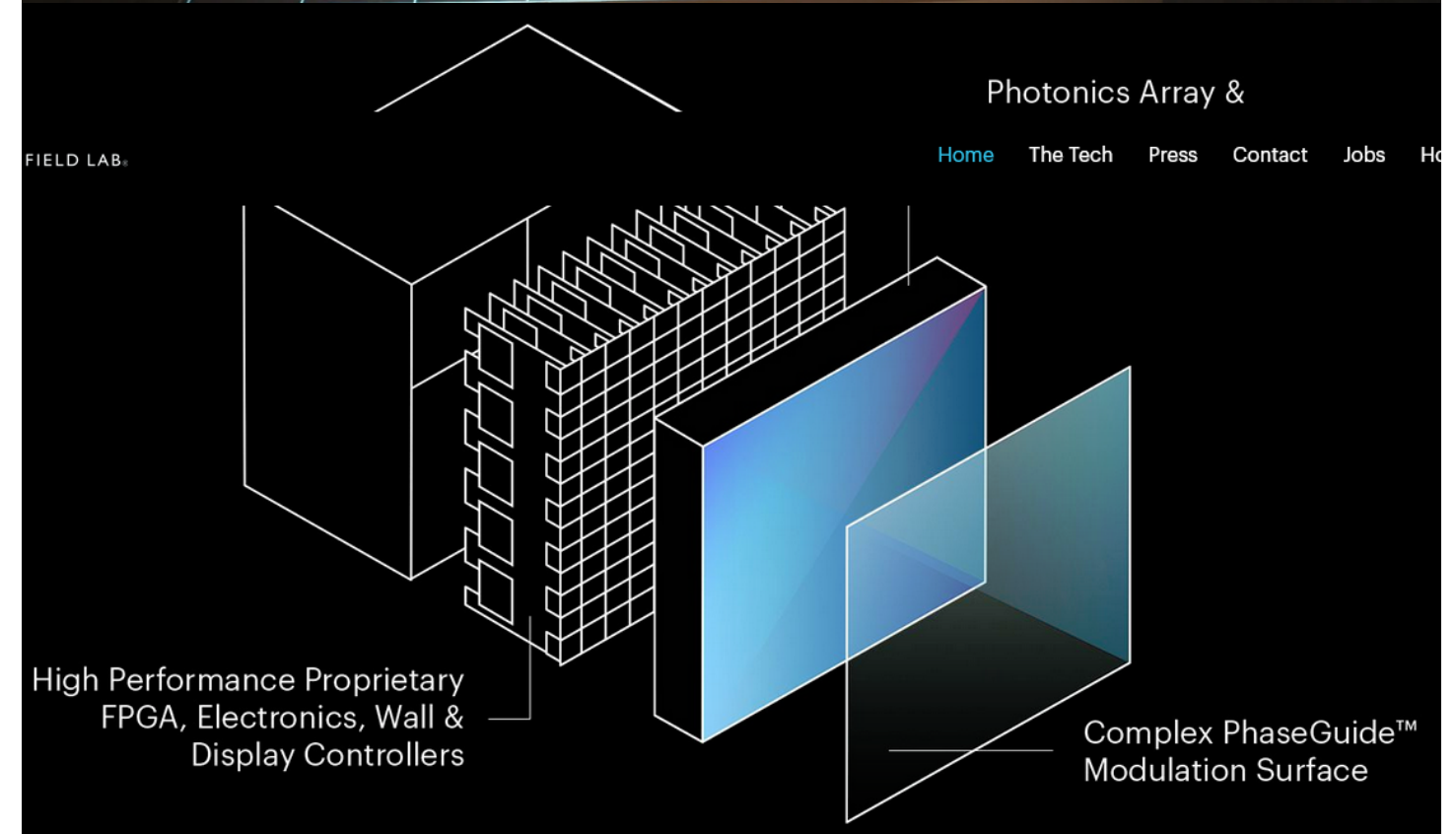
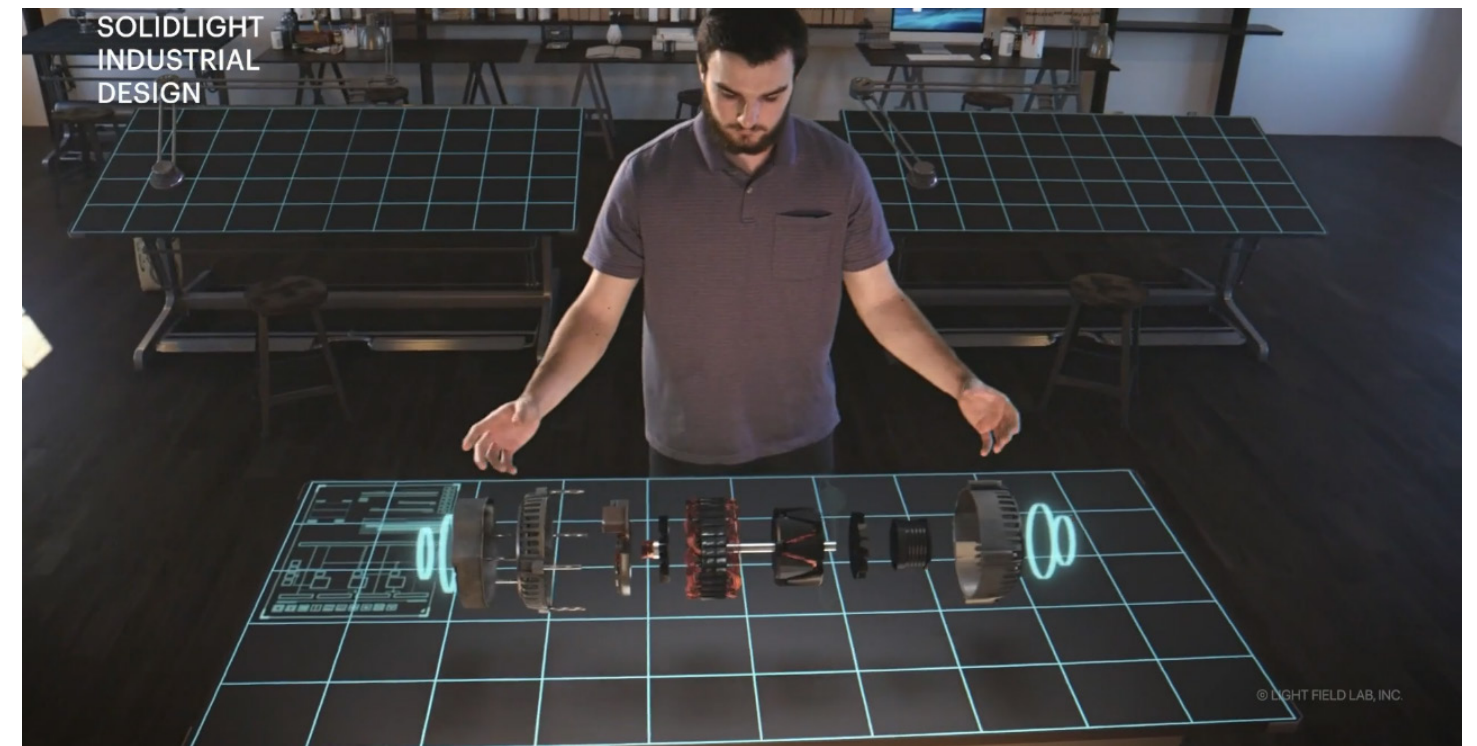

**The 25GbE Fiber Optic Cameras can be sent
Near Real-Time over Starlink to another FtISpinUp unit
Thousands of miles away and displayed on the
Light Field Labs display in 3D with computer conversion
of strategically placed cameras**

**Codex Grandeur LLC has no connection to Canon, or
Light Field Lab.**

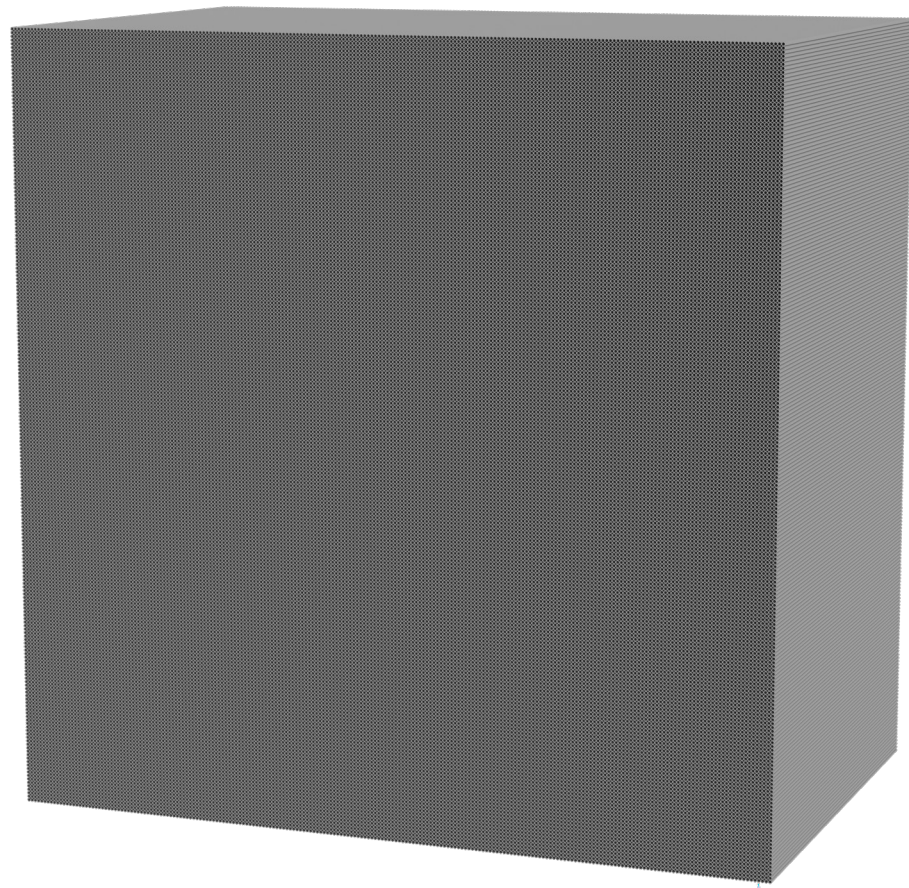

Rough Approx.
216 X 216 Pipes
=10,964,533,248
~410TbE Fiber Strands
Same Number of
Bytes over 1 Single
1GbE at (2^52)
[Experimental]

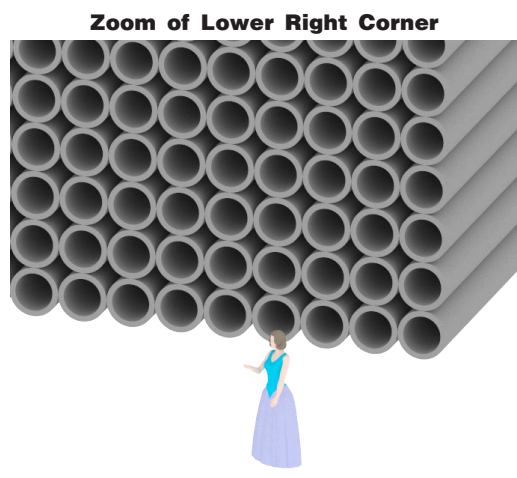

450 359 962 737 049 600 000 000 Bytes
 Zetta Exa Peta Tera Giga Mega Kilo Hecto

Same # of bytes sent over 1 single 1GbE in 1.0 Seconds
450,359,962,737,049,600,000,000 Bytes / (2^52)=100,000,000Bytes
100,000,000 Bytes over 1GbE = 1.0 Seconds
1.0 Seconds over 1 single 1GbE up/down Line

OR

Same bytes sent over 46,656 Pipes full of ~410TbE in 1 Second
450,359,962,737,049,600,000,000 = No Subspace Conversion
450,359,962,737,049,600,000,000 / ~410TbE = 10,964,533,248
10,964,533,248 ~410TbE Fiber Strands 1.0 Full Second

26-in. HDPE sleeve with 34 (2-in. 6912 Fiber Strands) per pipe
34 X 6912 = 235,008 ~410TbE Fiber Strands per pipe
10,964,533,248 / 235,008 Fiber Strands per pipe
= approx. 46,656 Pipes

Square Root 46,656 = 216 X 216 Pipes of ~410TbE Fiber Strands
Continuous Run for 1.0 Full Second

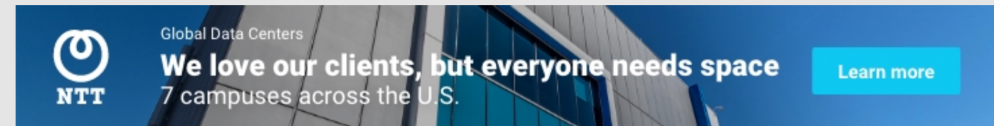

PODCAST

Data Center Fiber at Gigawatt Scale: A Talk With Quantum Loophole CEO Josh Snowhorn

The Cabling Podcast sits down with Josh Snowhorn, founder and CEO at Quantum Loophole, to discuss the massive QLoop fiber ring project under the Potomac.

DCF Staff
 April 21, 2023



Quantum Loophole CEO Josh Snowhorn testing one of the giant conduits that will house fiber for the QLoop, the company's fiber ring connecting the new campus to Data Center Alley in Northern Virginia.



Data centers are more than just the sum of their parts and there



VOICES OF THE INDUSTRY



SPONSORED CONTENT
Collaboration is Multiplication: Listening and...

Phillip Marangella, Chief Marketing and Product Officer at EdgeConneX, shares his perspectives on why collaboration is the key to meeting the needs of data center customers.

[Voices of the Industry](#)

are far more pieces in play than most people outside the industry would consider. Connectivity is one of the key functions external to the data center that enables effective operation, and as such, we focus significant efforts in providing coverage of the activities of both the technology and the industry supporting these options.

Josh Snowhorn is founder and CEO at [Quantum Loophole](#), an operator of [data center campuses](#) in the gigawatt scale. At DCF we've been providing regular updates on [Quantum Loophole](#) and its vision for "data center cities" since the company came out of stealth in early 2021. The company says it has already leased a massive [240 megawatts of capacity](#) at its campus in Adamstown, Maryland.

Central to the entire undertaking is [QLoop](#), the 43-mile hyperscale fiber ring connecting Quantum Loophole's 2,100+ acre [data center development site](#) in Frederick County, Maryland to the Data Center Alley connectivity ecosystem around Ashburn, Virginia.

ADVERTISEMENT



In a recent edition of [The Cabling Podcast](#), our sister publication [Cabling Installation & Maintenance](#) checked in with Snowhorn for an update on the construction of data center and fiber conduit infrastructure.

Snowhorn said the projects is the largest medium haul fiber backbone that's ever been created. The QLoop network ring network ring offer capacity for more than 200,000 strands of fiber connecting to the Ashburn ecosystem in under one half millisecond Round Trip Time (RTT). "And we are bolstering that with some pretty amazing cross-connect capabilities," he added.

LATEST IN PODCAST

How Investment Powers the Global Growth o... NTT/RagingWire Jan. 26, 2023

What the Chip Revolution Means for Data... Vertiv Jan. 12, 2023

The Top Data Center Frontier Show Podcasts... Rich Miller Dec. 22, 2022

A Deep Dive Into Immersion Cooling with J... TMGcore Dec. 5, 2022

DCF Show: The Growing Urgency of Dat... Schneider Electric Nov. 15, 2022

WHITE PAPERS



SPONSORED CONTENT The Secret to Building Data Centers Faster ...

To meet the needs of the rapidly expanding global colocation market, a significant amount of new infrastructure must be built quickly. Project buffering can eliminate many of ...



"Each property will have access to conduits and thousands of strands of fiber directly into the QLoop system to enable seamless, private and secure connectivity for all of our campus-wide customers."

Here's the podcast with CIM host Matt Vincent, followed by a summary of the key discussion points.

Gigawatt-Scale Data Center Fiber

A frequent speaker at industry conferences, Snowhorn's key founding and executive positions include time at Terremark, Verizon, Cincinnati Bell, and CyrusOne. Snowhorn founded the Global Peering Forum, the annual meeting for the Internet interconnection and peering community, where he serves on the board of directors. He also serves on the advisory board of [Telescent](#), a maker of automated data center interconnection machines.

As the discussion begins, Snowhorn provides an update on (1:46) underground fiber infrastructure linking up Quantum Loophole's Frederick data center campus' network center 1 and 2 sites, "which



Energy as a Service (EaaS) Solutions for Data Centers

LEARN MORE





Quantum Loophole Founder and CEO Josh Snowhorn speaks to The Cabling Podcast.

Splicing Skills and Automated Connections

Later in the interview (6:36), Matt asks how working with a high-fiber-count cable like 3456 is different from working with 144-fiber cable (which the world used to consider high-fiber-count), and if installers had to to "level up" on their splicing skills or any other installation skills to get comfortable working with this high-fiber count fiber.

QLoop's press coverage mentions (7:51) that its network infrastructure has a radius that will accommodate 6912-fiber availability. In response to this info, we asked Snowhorn if his teams have worked with that fiber count yet; and if so, if there's been a noticeable difference between it and 3456-fiber cable.

Snowhorn also shared (9:07) his insights regarding the value proposition of automatic, robotic cross connections powered by Telescent, as installed at Quantum Loophole's Maryland data center campus.

"It really comes out of a need to change how people do interconnection. Your classic way of doing it is either truck rolls to a remote hut, or having 24x7 staff with tickets open, and hopefully no RX/TX reversals in play. But when you start thinking about the scale of what we're building, with more fiber strand count coming into a single location than anyone's ever seen, that really starts to bring in a need for change. The Telescent machines do something quite unique in that we can give the control of the interconnection to the client, so they can use a portal via an API, log in,

and enable a cross-connect in 2 minutes without ever touching it as long as the machine has been pre-patched.

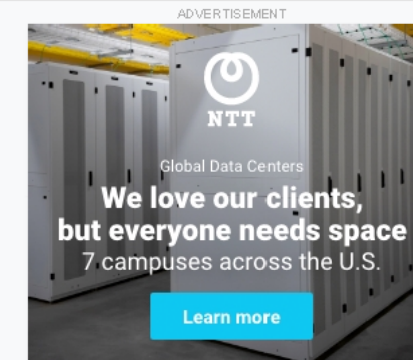

The bigger picture of that is they have the same machine on their campus and building, and then maybe they have the same machine located in Ashburn and Manassas, let's say 20 buildings, and they want to enable an interconnection. The machine has a built-in OTDR, they can punch light out, they can verify the connection and do 20 connections at the same time, all in 2 minutes, and batch a job. They can do 1,000 connections in 2,000 minutes theoretically, across 20 locations, without a human being touching it. That's game-changing. That really creates flexibility for outages, creates hopefully a reduction in truck roll and labor costs, and a more rapid delivery of interconnection."

As the QLoop is such a notably large outside and inside plant undertaking for data center construction, to close out the podcast (11:30) we asked Snowhorn for a recap of the project's specifications and a preview of what's in store for the rest of the year. In response, Snowhorn said:

"It's literally hundreds of sites, hundreds of data centers, but we don't actually touch those other data centers once we get into Loudon County. We

cross the Potomac, which is insanely hard to do: I now know why nobody tries to do it, because it's that hard. It's just been nothing but a struggle to get it done, but we're doing it. I don't think anybody's going to try and do it again for a long time. Machines blowing up, costs, the approvals -- going 9 stories below the bedrock of the Potomac is insane. The costs are through the roof -- I cannot think of a single thing that was easy about what we've done.

We drop down [and] have over 500 vaults on the 43-mile ring, and those vaults are designed to create a massive intersection of splice points, so that people can tie into the system. We're a wholesaler to the wholesalers, so our goal was not to go build throughout the entire Ashburn corridor and interconnect every building and be another competitive carrier. We wanted to be a support mechanism to create an expansion of that ecosystem."

ADVERTISEMENT

DCIM for modernized data centers – made simpler.
EcoStruxure™ IT Advisor
A planning, modeling and optimization tool.
Life Is On | Schneider Electric | Learn more

Improve data center efficiency with DCIM.
EcoStruxure™ IT Advisor
A planning, modeling and optimization tool.
Life Is On | Schneider Electric | Learn more

This article

PODCAST

How Investment Powers the Global Growth of the Cloud



The Seagate Exos E SU84 storage enclosure supports 84 3.5 inch disk drives in a 5U box. A typical 42U rack cabinet will hold about 8-84 disk drive enclosures each.

FtlSpinUp (2^{26}) will convert one single disk drive into the storage capacity of 67,108,864 disk drives, any size. $67,108,864 / 84 = 798,915$ disk drive enclosures pictured above. $49,932 / 8 = 99,865$ Cabinets full of disk drives. The electrical power and cost of physical space alone will pay for many, many, many FtlSpinUp units instantly, not to mention the cost of all the disk drives that will wear out eventually, compared to the one single disk drive FtlSpinUp uses.

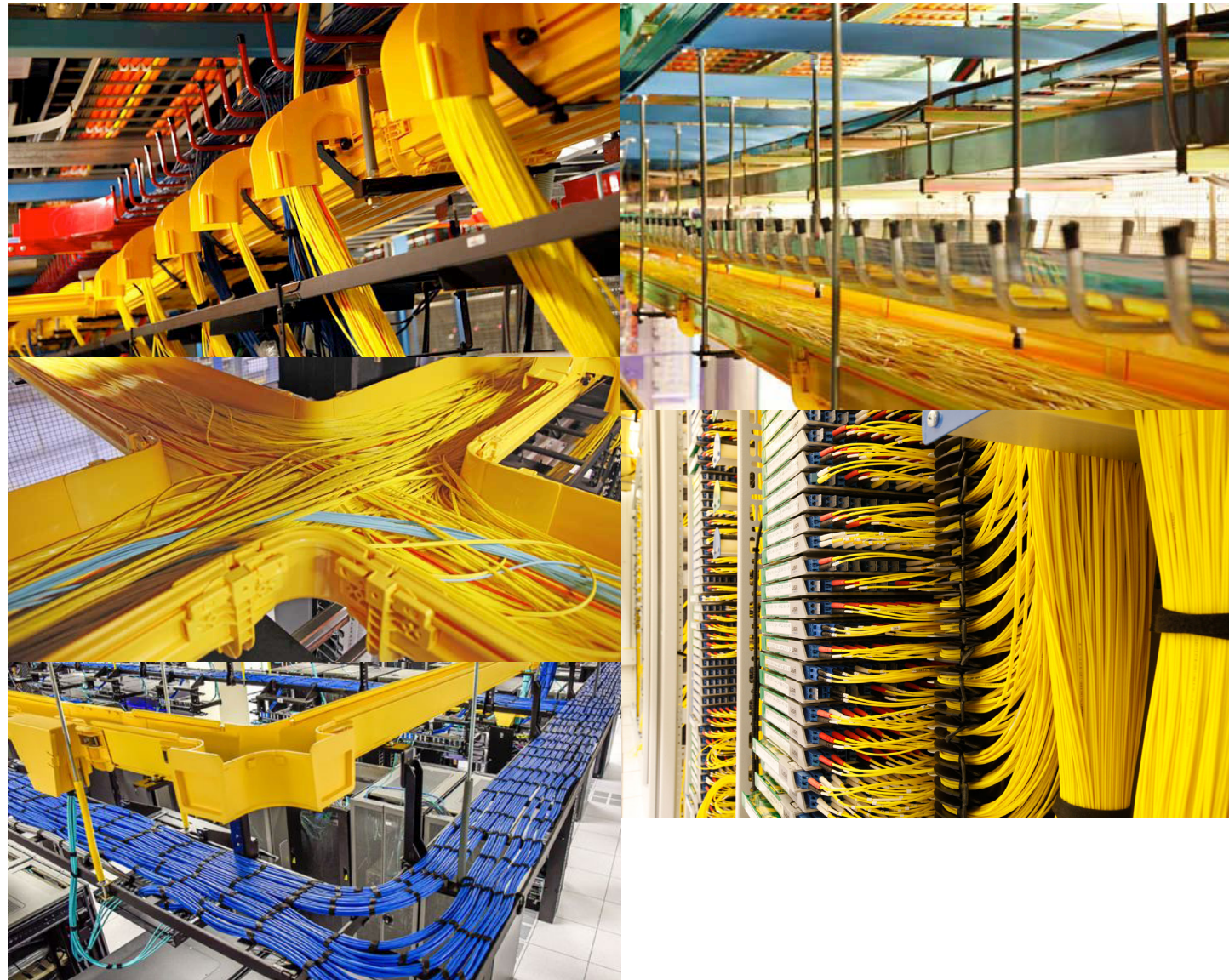

FtlSpinUp Supercomputer

Cargo Bit at (2^{26}) operating at near real-time performance, and each single low cost 10GbE FDX link can carry the same generated, or previously converted data as 67,108,864 separated 10GbE FDX links near real-time. This makes the signal interaction of every single CPU processor can be simultaneously linked to any other CPU processor by any combination of the 128 PCIe lanes or SDRAM channels near real-time. ANY-ANY.

The RAM disk, SSD, input, output, program linkage, and more are supported by the FtlSpinUp. Local or long range communication is enhanced by every single 1 bit transmitted over fiber optics, or any physical transmission system running at the speed of light, another 67,108,863 bits will also arrive at the same exact time. 67,108,863 bits travel Faster Than Light.

Once characterized the hardware components will not be required. More cores are required for near real-time simultaneous conversions.

Complete CPU processors have the performance of Central Processor Unit (CPU) internal registers due to the data propagation increase possible in a running program memory distributed across large scale random access matrix, matched with a CPU large scale random access matrix.

Because of the massive amount of data storage available in FtlSpinUp, many CPU functions, and or GPU functions can be stored directly “canned”, eliminating the need for hundreds or thousands of actual physical processors.

Massive reduction in cable networks is possible.

[Possible Application]

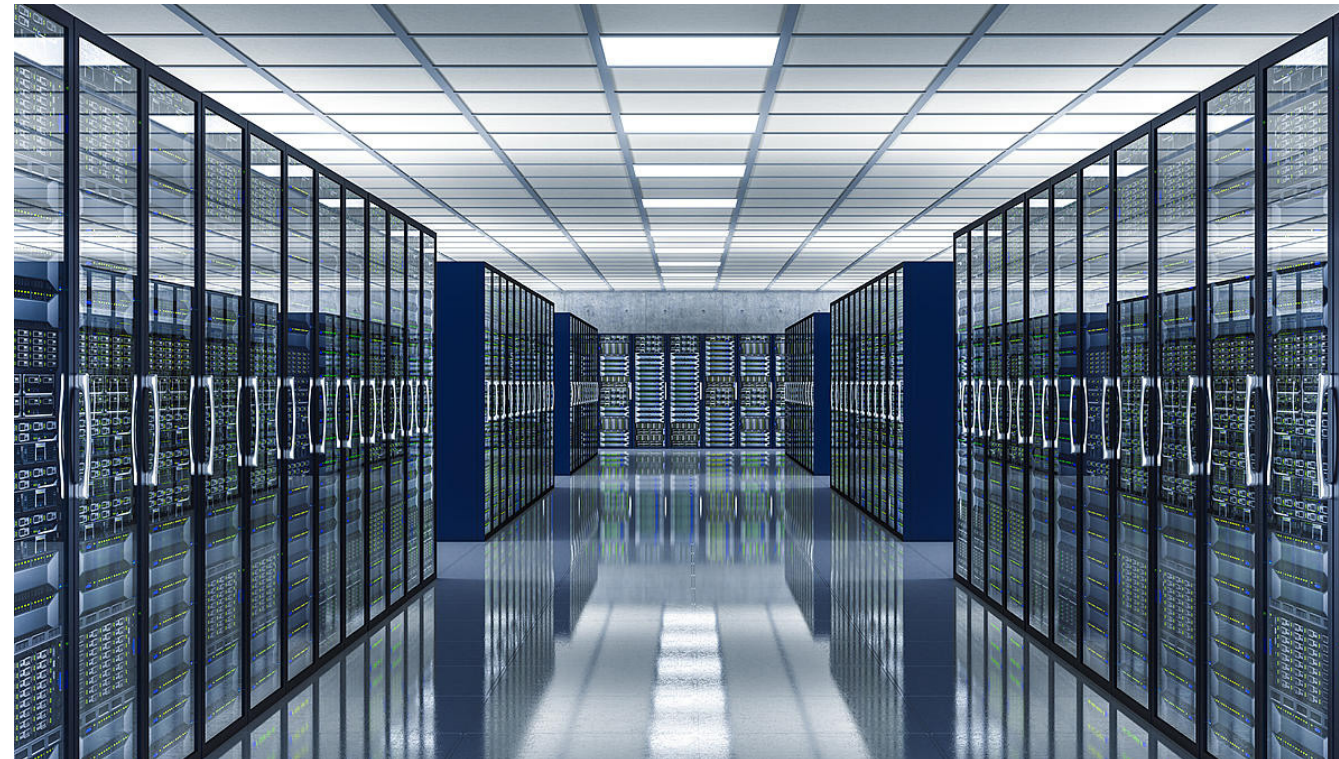

Magnitudes More Space with Magnitudes Less Data Storage



**Small Data Centers Win against Large Data Centers
With FtlSpinUp**

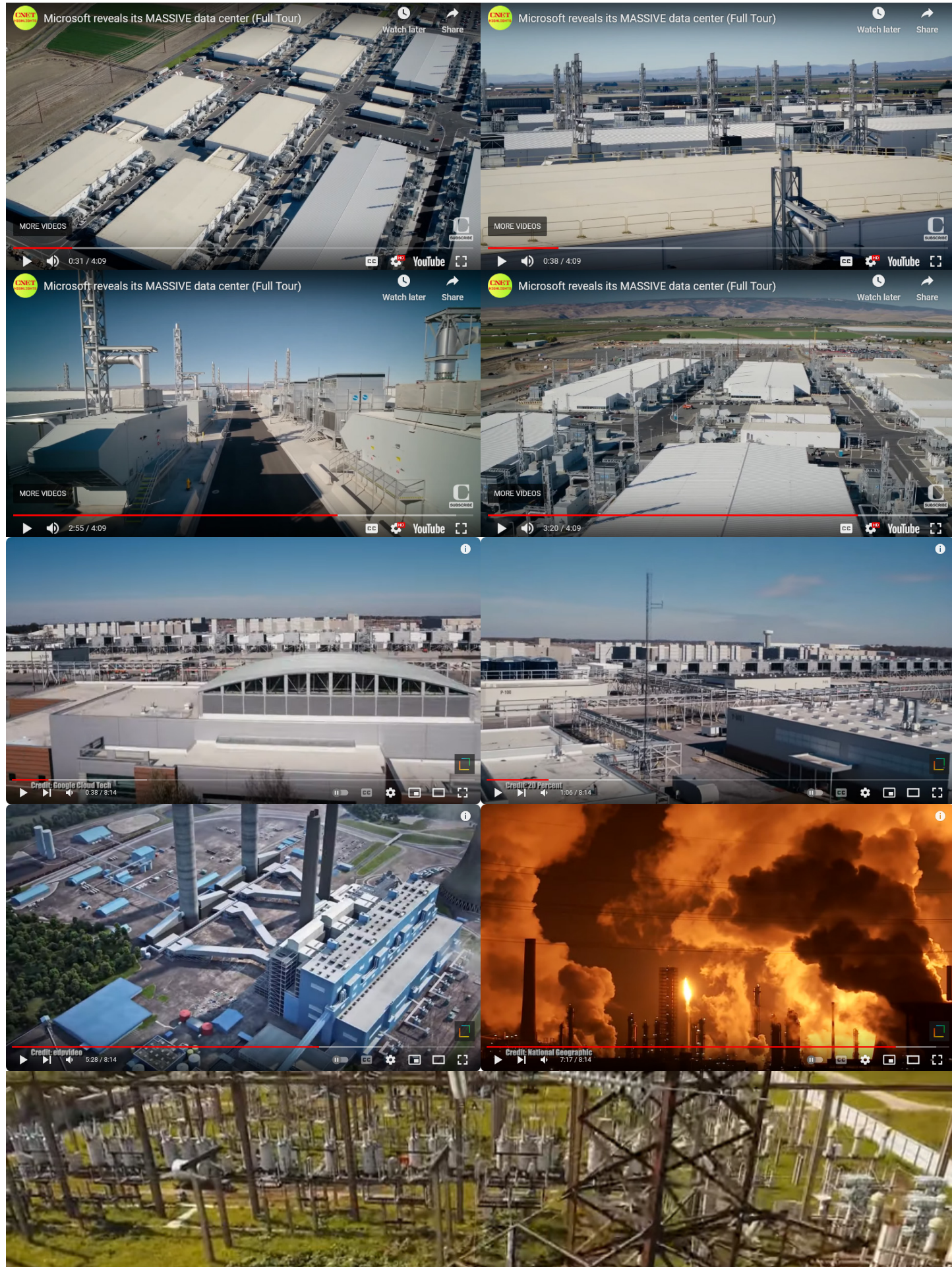

Prefix	Symbol	1000 ^m	10 ⁿ	Decimal	Short scale	Long scale	Since ^[n 1]
yotta	Y	1000 ⁸	10 ²⁴	1 000 000 000 000 000 000 000 000	Septillion	Quadrillion	1991
zetta	Z	1000 ⁷	10 ²¹	1 000 000 000 000 000 000 000	Sextillion	Trilliard	1991
exa	E	1000 ⁶	10 ¹⁸	1 000 000 000 000 000 000	Quintillion	Trillion	1975
peta	P	1000 ⁵	10 ¹⁵	1 000 000 000 000 000	Quadrillion	Billiard	1975
tera	T	1000 ⁴	10 ¹²	1 000 000 000 000	Trillion	Billion	1960
giga	G	1000 ³	10 ⁹	1 000 000 000	Billion	Milliard	1960
mega	M	1000 ²	10 ⁶	1 000 000	Million		1960
kilo	k	1000 ¹	10 ³	1 000	Thousand		1795
hecto	h	1000 ^{2/3}	10 ²	100	Hundred		1795
deca	da	1000 ^{1/3}	10 ¹	10	Ten		1795
		1000 ⁰	10 ⁰	1	One		–
deci	d	1000 ^{-1/3}	10 ⁻¹	0.1	Tenth		1795
centi	c	1000 ^{-2/3}	10 ⁻²	0.01	Hundredth		1795
milli	m	1000 ⁻¹	10 ⁻³	0.001	Thousandth		1795
micro	μ	1000 ⁻²	10 ⁻⁶	0.000 001	Millionth		1960
nano	n	1000 ⁻³	10 ⁻⁹	0.000 000 001	Billionth	Milliardth	1960
pico	p	1000 ⁻⁴	10 ⁻¹²	0.000 000 000 001	Trillionth	Billionth	1960
femto	f	1000 ⁻⁵	10 ⁻¹⁵	0.000 000 000 000 001	Quadrillionth	Billiardth	1964
atto	a	1000 ⁻⁶	10 ⁻¹⁸	0.000 000 000 000 000 001	Quintillionth	Trillionth	1964
zepto	z	1000 ⁻⁷	10 ⁻²¹	0.000 000 000 000 000 000 001	Sextillionth	Trilliardth	1991
yocto	y	1000 ⁻⁸	10 ⁻²⁴	0.000 000 000 000 000 000 000 001	Septillionth	Quadrillionth	1991

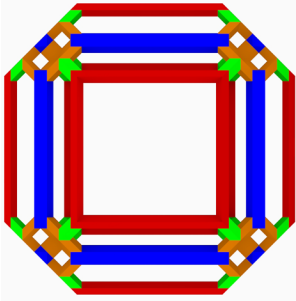

CODEX 
GRANDEUR

Codex Grandeur LLC

www.ftlspinup.com

www.cargobit.com

www.codexgrandeur.com

www.numericalanalog.com

email:

Info@ftlspinup.com

Info@cargobit.com

info@codexgrandeur.com

Info@numericalanalog.com

SMT *Robotics*
